

# INSEKTENSCHUTZ

für Fenster und Türen



Produktübersicht mit Preisen

WIR SCHAFFEN VERBINDUNGEN  
[www.nuessing.de](http://www.nuessing.de)

**Nüßing**  
... mehr als Beschläge

Ihr Partner für Technik und Design an Fenster, Tür und Möbel  
mit den Lösungen für Handwerk und Industrie.



**WERKZEUG**

---

**ELEKTROWERKZEUG**

---

**ARBEITSSCHUTZ, BETRIEBSEINRICHTUNG UND WORKWEAR**

---

**FENSTER- UND LÜFTUNGSTECHNIK**

---

**SCHIEBETÜRTECHNIK**

---

**FENSTER- UND TÜRPROFILE**

---

**SCHLIESS- UND ÖFFNUNGSTECHNIK**

---

**BANDTECHNIK**

---

**FENSTER- UND TÜRGRIFFE, BRIEFKÄSTEN**

---

**BEFESTIGUNGSTECHNIK UND MONTAGEMATERIALIEN**

---

**MÖBELBESCHLÄGE**

---

**OBERFLÄCHENTECHNIK, LEIME UND KLEBER**

---

**BAUELEMENTE UND FÜLLUNGEN**

---

## 230 Rahmenprofil-C Easy<sup>2</sup>

» **Geeignet für:**  
für alle flächenversetzten Fenster  
ohne Wetterschenkel

Bei diesem Beschlag messen Sie einfach das lichte BLR-Maß des flächenversetzten Fensters. Der Insektenschutz-Rahmen steht komplett im lichten Blendrahmen. Deshalb können Fenster-Gitter, Rollläden, Mauerleibungen, zurückspringende Kämpfer etc. völlig außer acht bleiben.

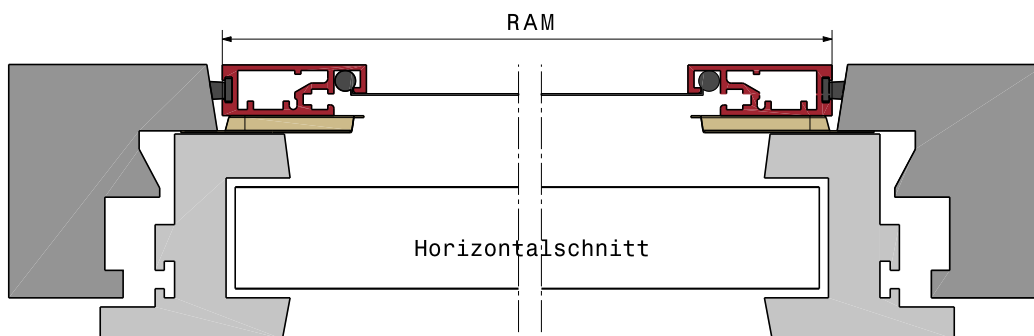
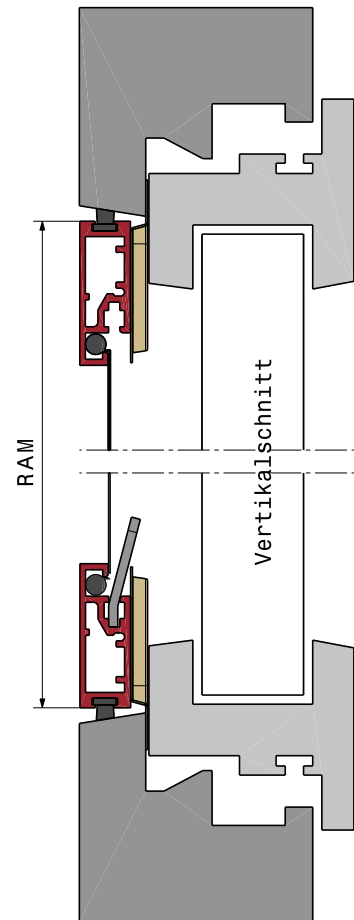

### Profilübersicht



Rahmen-C



Kämpferprofil



## 230 Rahmenprofil-C

EASY<sup>2</sup>

Rahmenprofil-C 10mm Bürste umlaufend  
KS-Griff unten mittig

RAM Breite = licht. BLR - 5mm

RAM Höhe = licht. BLR - 5mm

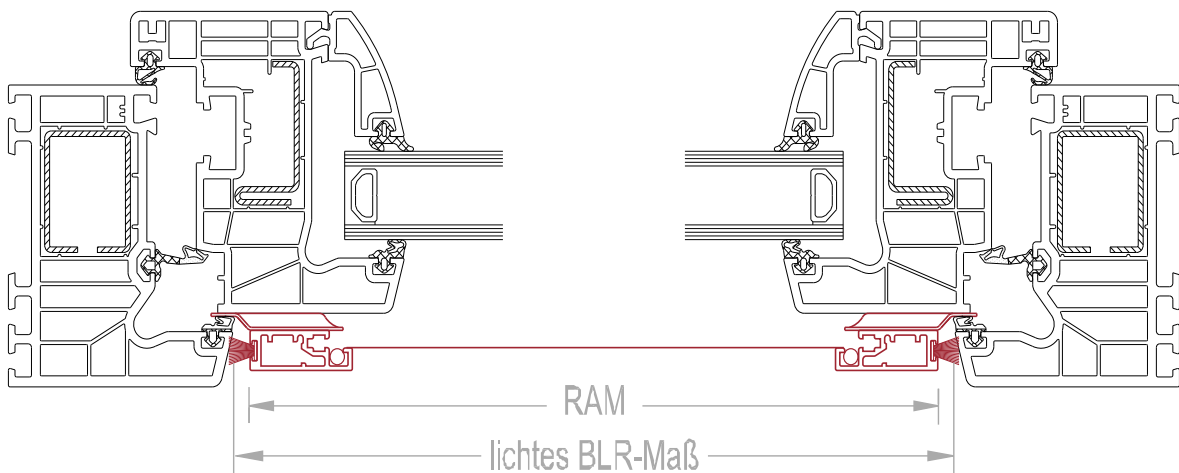
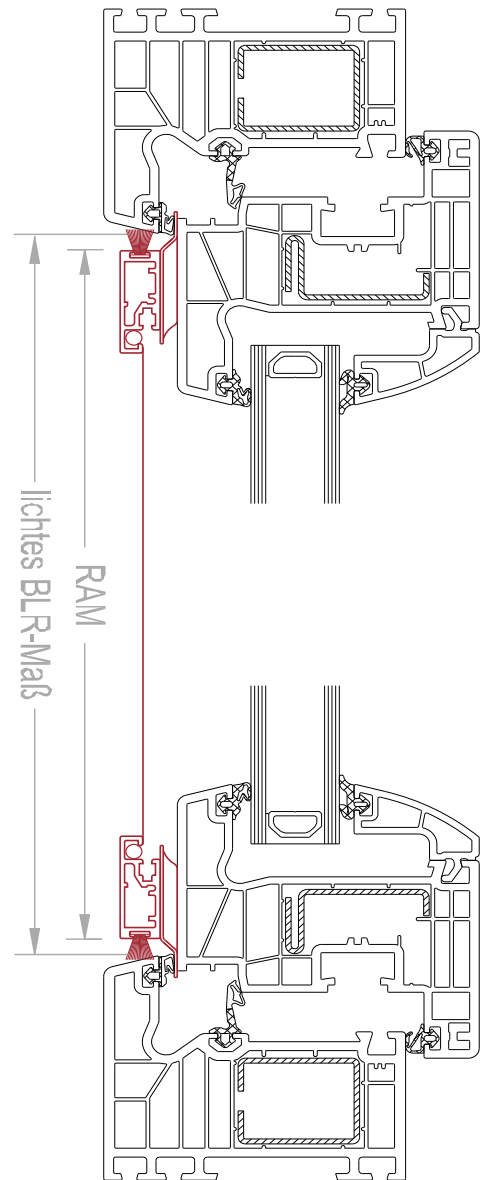
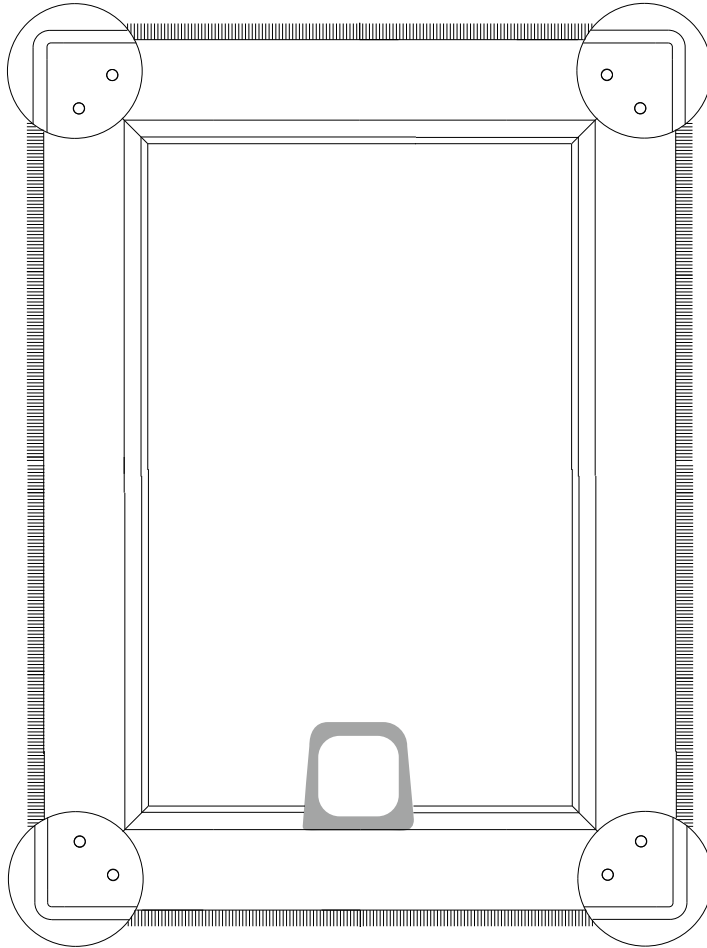

Bitte beachten:

Nur für flächenversetzte Fenster ohne  
Wetterschenkel o.ä.

< 1500mm mit gewebeteilender Sprosse

## 230-XL Rahmenprofil-C

EASY<sup>2</sup>

Rahmenprofil-C 10mm Bürste umlaufend  
senkrecht XL-Profil  
KS-Griff unten mittig

RAM Breite = licht. BLR - 5mm

RAM Höhe = licht. BLR - 5mm

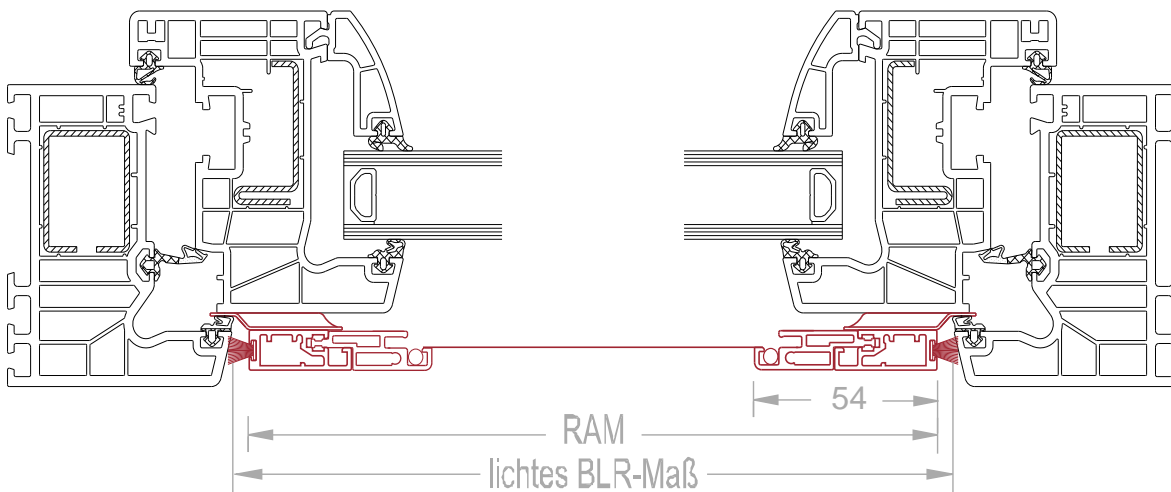
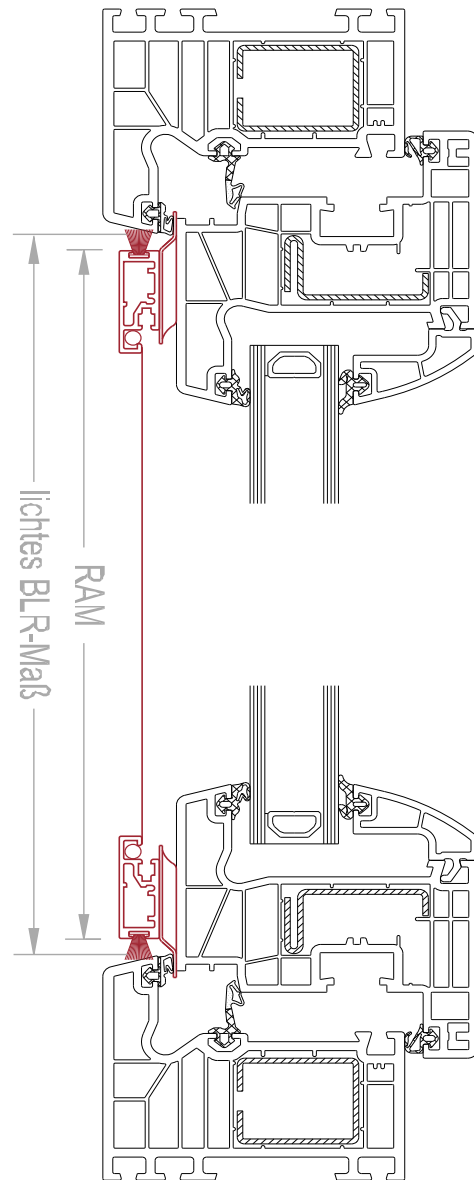
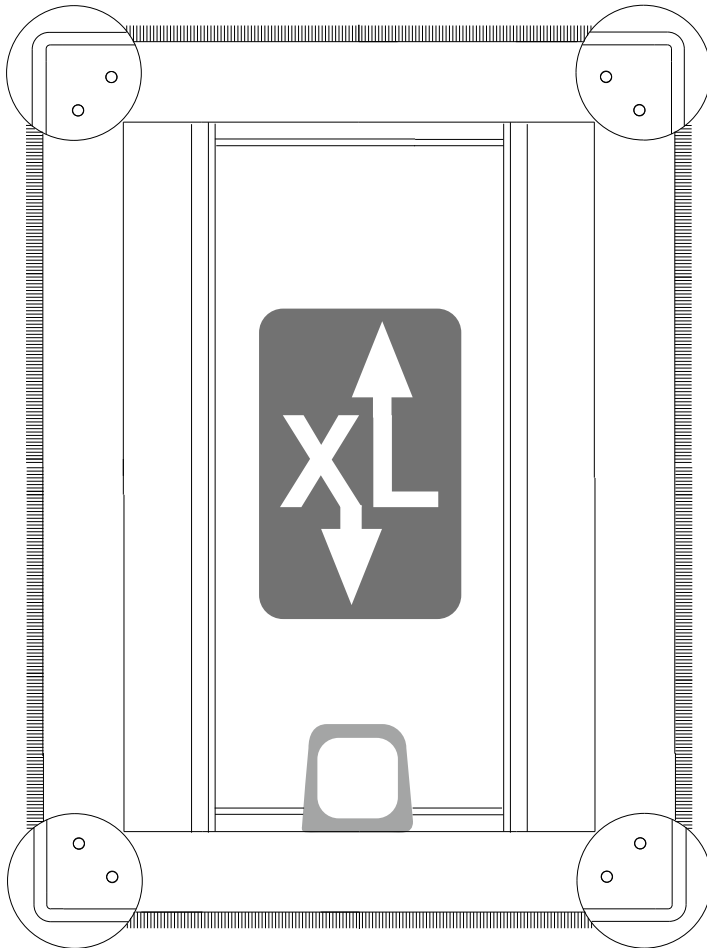

Bitte beachten:  
Nur für flächenversetzte Fenster ohne  
Wetterschenkel o.ä.

Mehrpreis Easy XL = 35,-€ je Rahmen



230 Rahmenprofil-C  
 EASY<sup>2</sup> für Holzfenster **ohne Flügelfalz**  
 Rahmenprofil-C 10mm Bürste umlaufend

RAM Breite = licht. BLR - 5mm  
 RAM Höhe = licht. BLR - 5mm

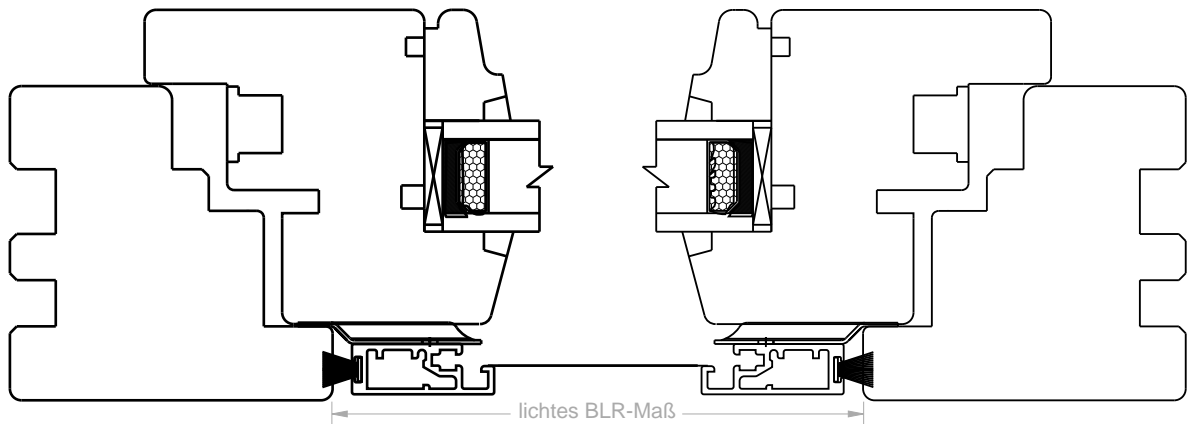
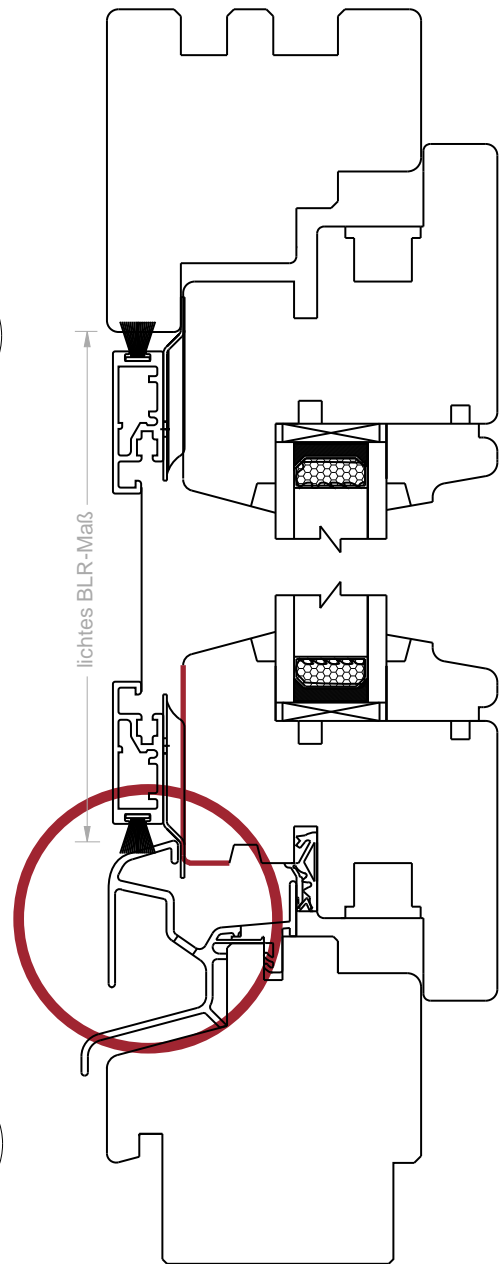
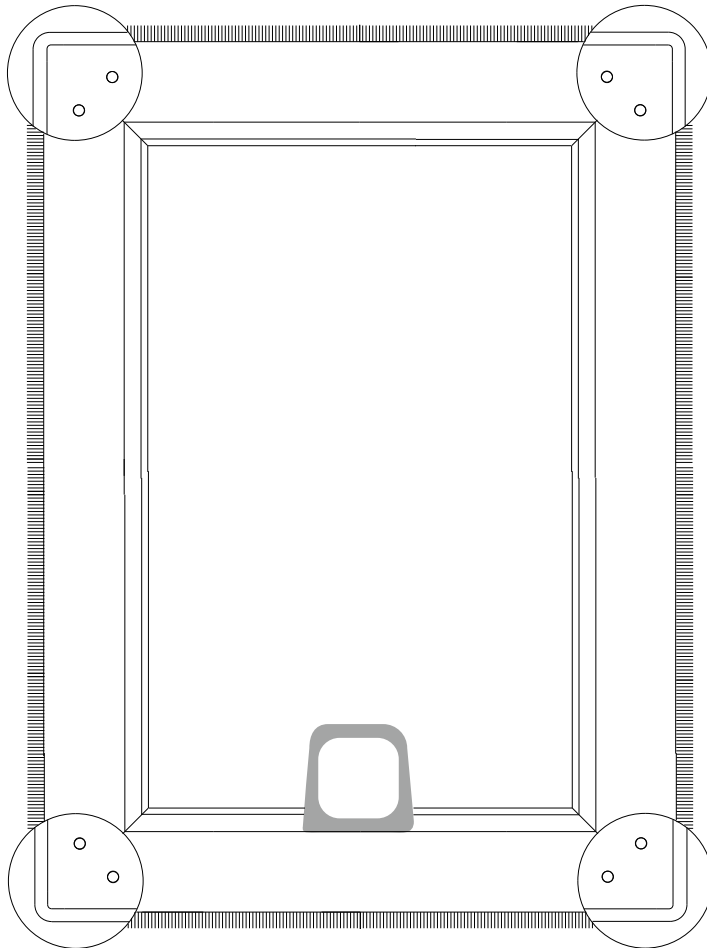

Bitte beachten:  
 Nur für flächenversetzte Fenster ohne Flügelfalz,  
 Wetterschenkel, Flügelabdeckprofil o.ä.

## 230.1 Rahmenprofil-C

EASY<sup>2</sup> für Holzfenster mit Flügelfalz unten  
 Rahmenprofil-C 10mm Bürste umlaufend

RAM Breite = licht. BLR - 5mm  
 RAM Höhe = licht. BLR - 5mm

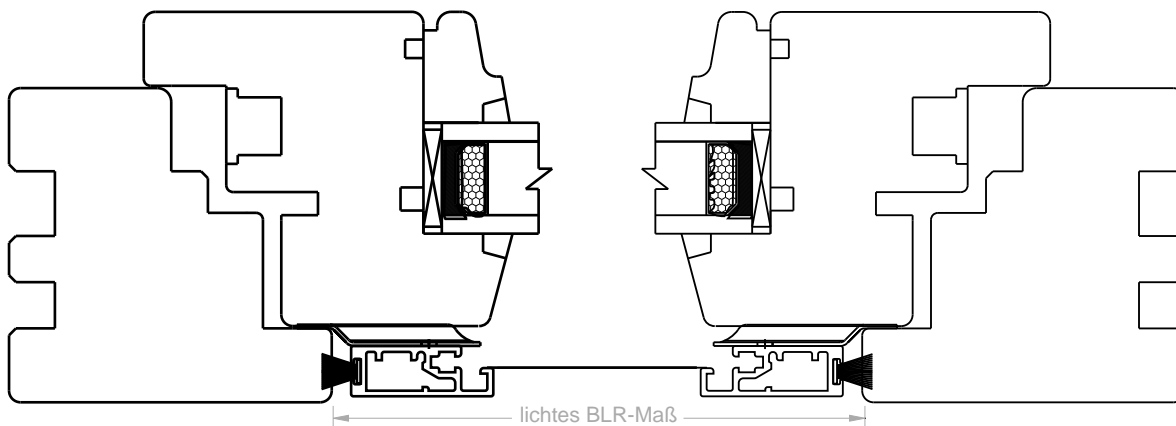
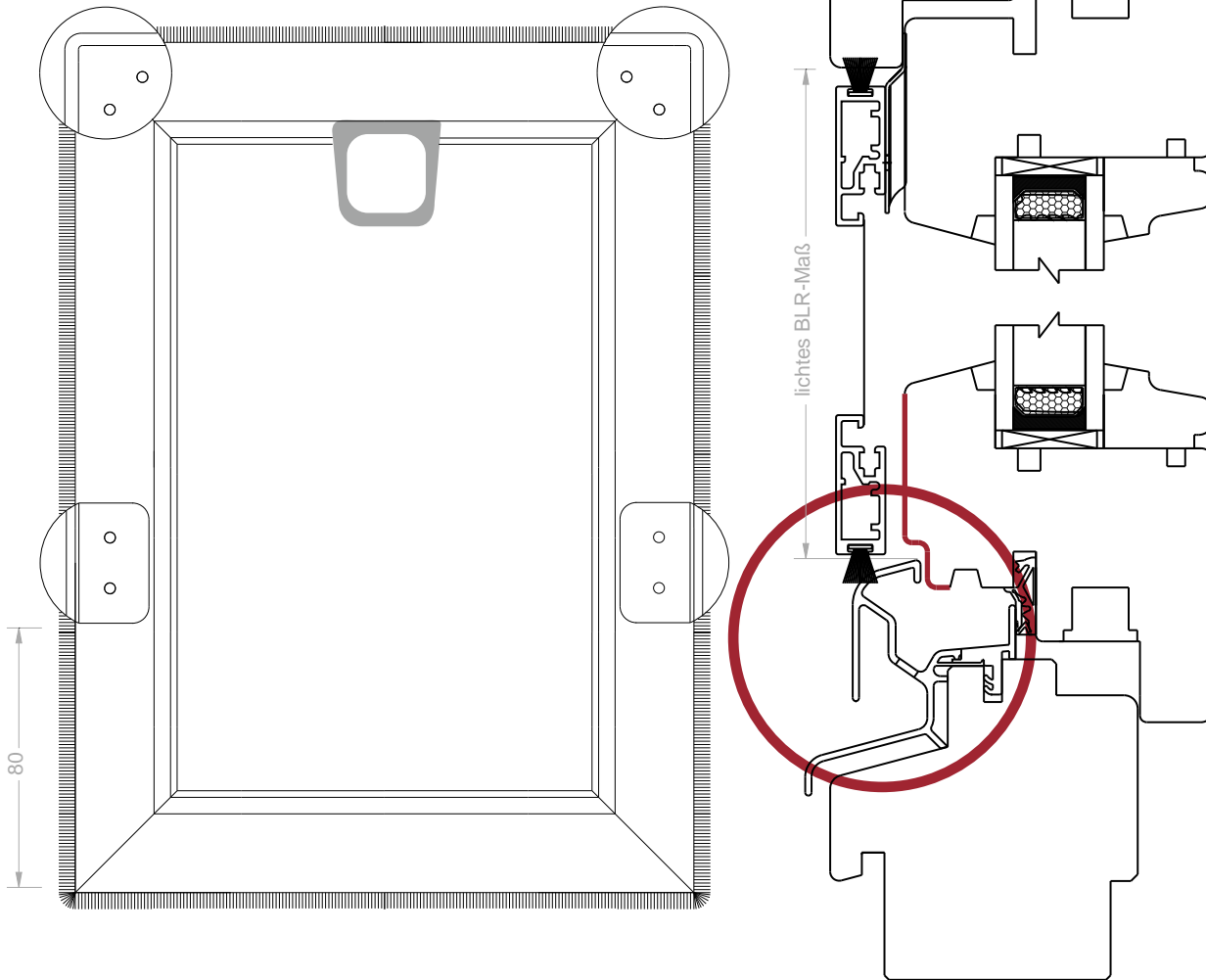

**Bitte beachten:**  
 Nur für flächenversetzte Fenster ohne  
 Wetterschenkel, Flügelabdeckprofil o.ä.  
 Der Fliegengitter-Rahmen steht auf der  
 Regenschutzschiene. KS-Griff oben.



### 230.2 Rahmenprofil-C

EASY<sup>2</sup> für Holzfenster mit Flügelfalz unten  
Rahmenprofil-C 10mm Bürste umlaufend

RAM Breite = licht. BLR - 5mm  
RAM Höhe = licht. BLR - 5mm

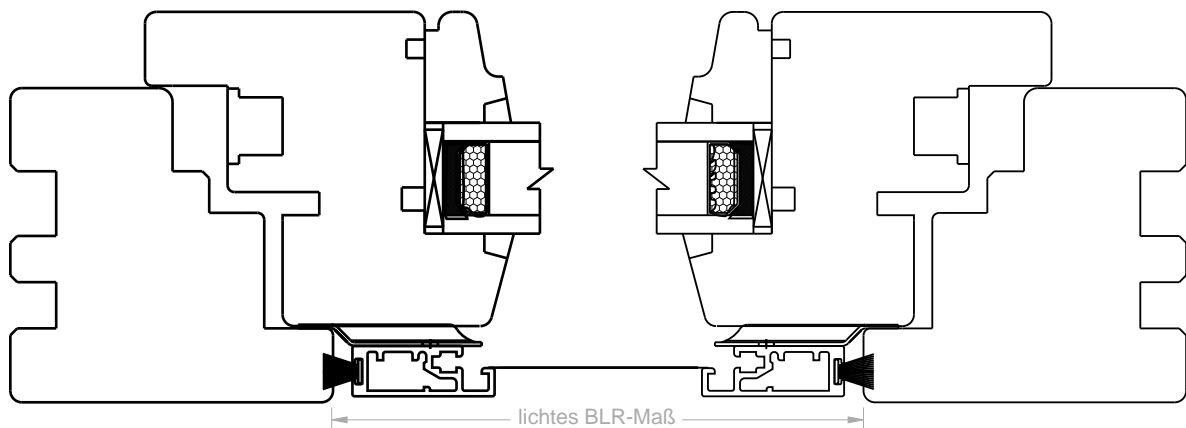
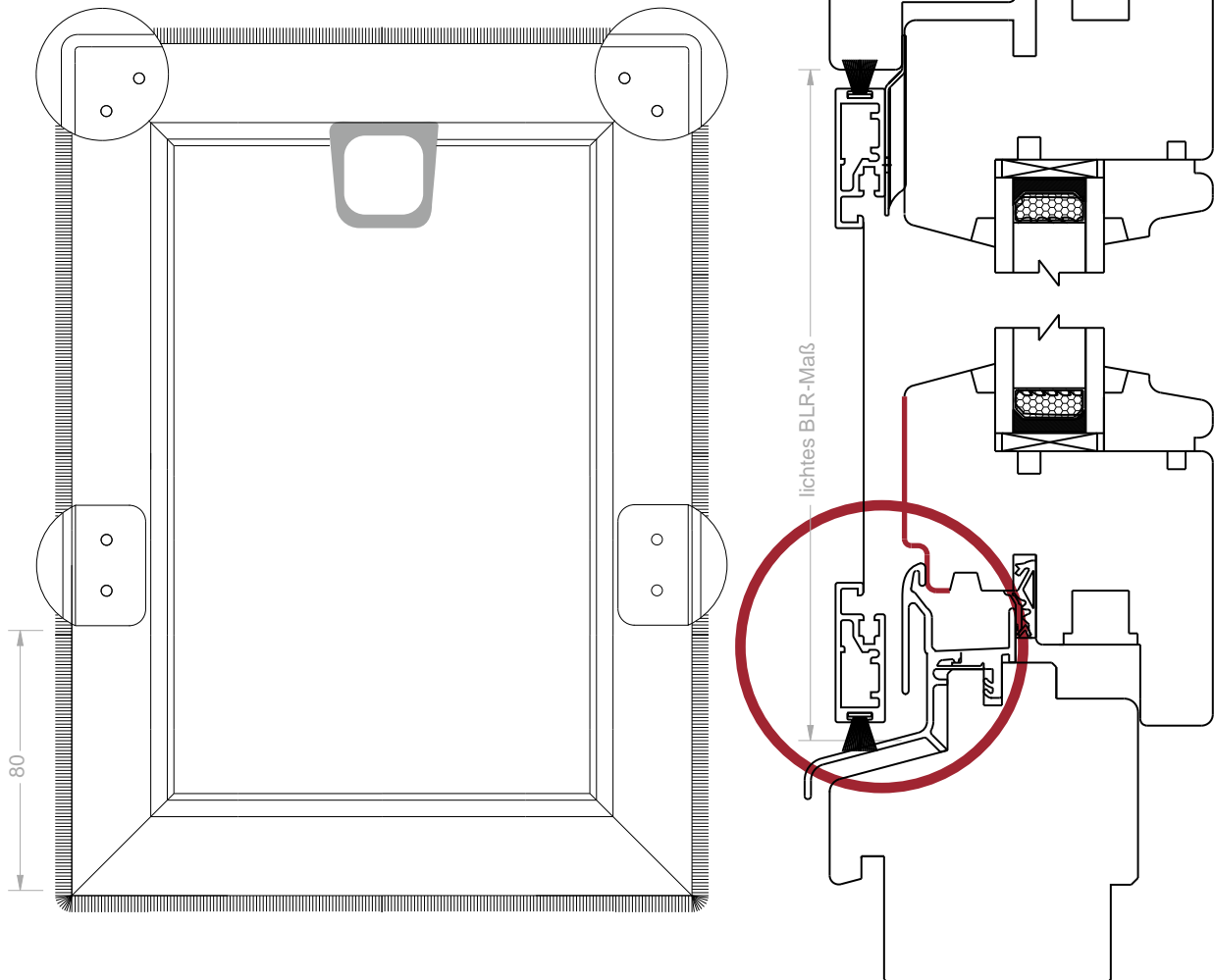

#### Bitte beachten:

Nur für flächenversetzte Fenster ohne  
Wetterschenkel, Flügelabdeckprofil o.ä.  
Der Fliegengitter-Rahmen steht auf der  
Stockabdeckung. KS-Griff oben.



## 230-Stulp Rahmenprofil-C

EASY<sup>2</sup> für Stulp-Fenster (Gangflügel)

Rahmenprofil-C 10mm Bürste umlaufend

RAM Breite = licht. BLR (Gangflügel) - 5mm

RAM Höhe = licht. BLR - 5mm

**230.SR** Stulppfosten rechts von aussen gesehen  
**230.SL** Stulppfosten links von aussen gesehen

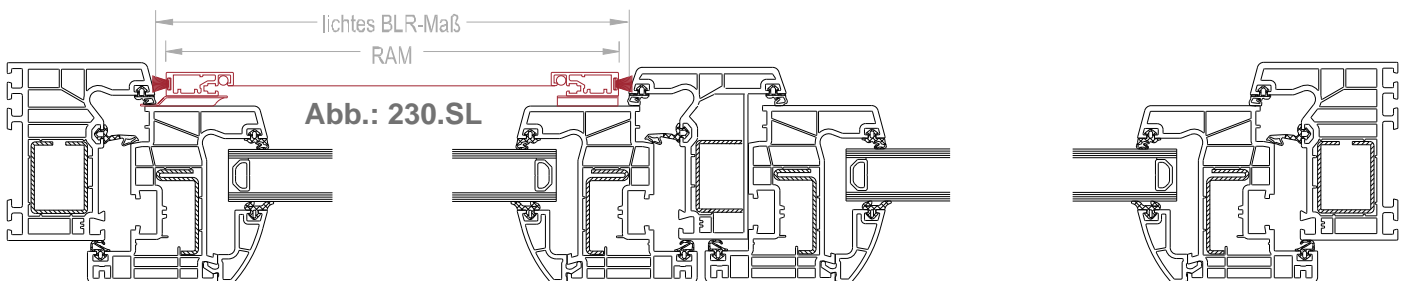
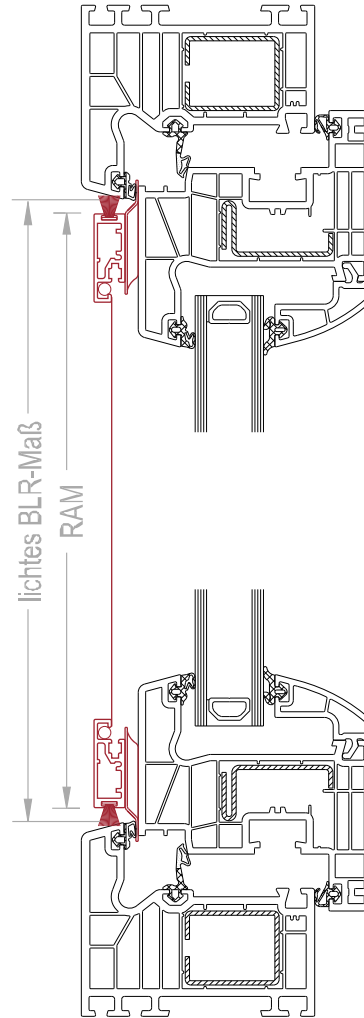
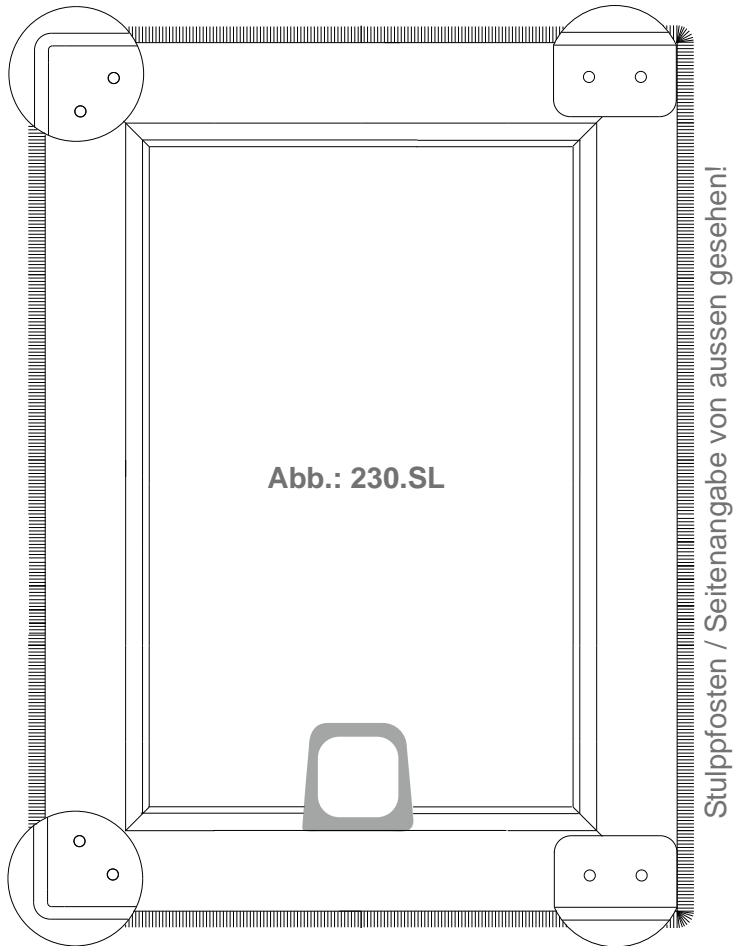

**Bitte beachten:**  
 Nur für flächenversetzte Fenster ohne  
 Wetterschenkel, Flügelabdeckprofil o.ä.  
 KS-Griff unten.

**236 Rahmenprofil-D**

Universa

RAM Breite = licht. BLR + 42mm  
 RAM Höhe = licht. BLR + 42mm

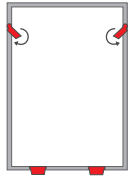
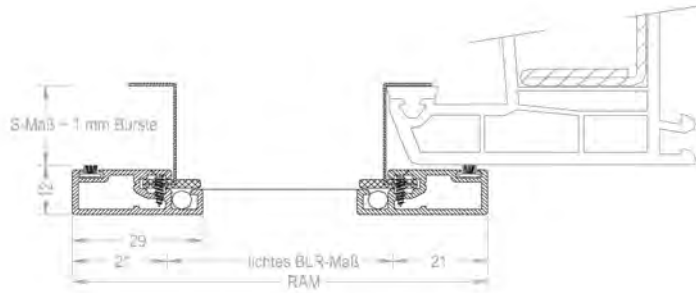
**237.FD Rahmenprofil-FD**

Universa auf dem Rahmen

RAM Breite = licht. BLR + 44mm  
 RAM Höhe = licht. BLR + 44mm

**238.FD Rahmenprofil-FD**

Universa in die Nut

RAM Breite = licht. BLR + 44mm  
 RAM Höhe = licht. BLR + 44mm

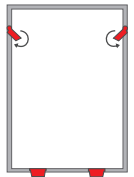
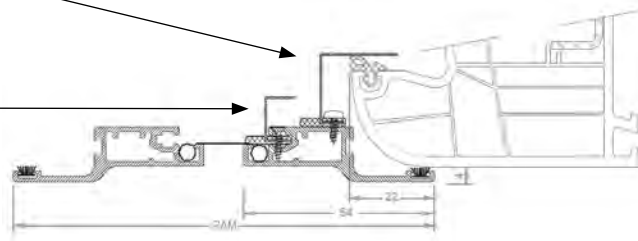
**239 Rahmenprofil-S**

Universa (Keder aussen)

RAM Breite = licht. BLR + 52mm  
 RAM Höhe = licht. BLR + 52mm

Speziell für:  
 Rolladenführungen < 12mm und  
 BLR mit großem Radius

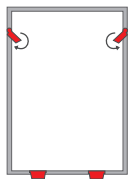
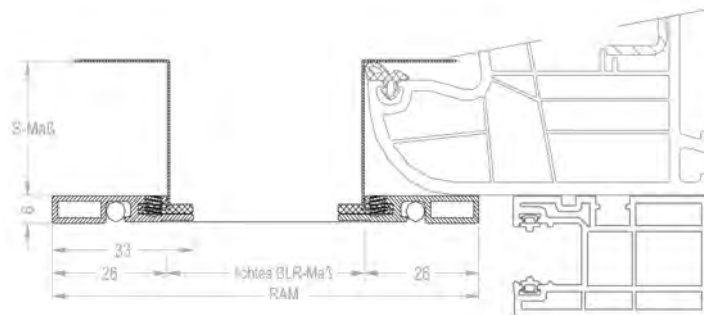

**236.1**

**Holzfenster - Regenschutzschiene ohne Stockabdeckung**

Universa alle seitlich drehbar / unten Winkelstücke  
 RAM Breite = licht. Blendrahmen + 42mm  
 RAM Höhe = licht. Blendrahmen + 30mm

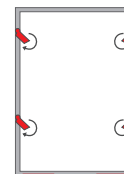
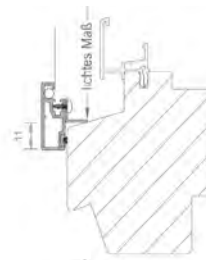

**236.2**

**Holzfenster - Regenschutzschiene mit Stockabdeckung**

Universa alle seitlich drehbar / unten Dichtband  
 RAM Breite = licht. Blendrahmen + 42mm  
 RAM Höhe = licht. Blendrahmen + 20mm

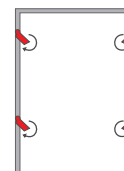
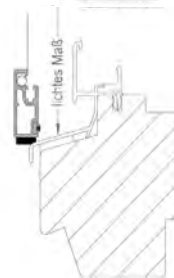

**236.3**

**Kunststoff- / Alu- / Holz-Alu-Fenster**

Sonderlösung:  
 sollte seitlich nicht genügend Platz auf dem BLR vorhanden sein  
 Universa unten fest / oben quer drehbar  
 RAM Breite = licht. Blendrahmen + vorhandener Platz  
 RAM Höhe = licht. Blendrahmen + 42mm

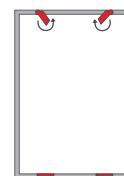

Breite	500	600	700	800	900	1.000	1.100	1.200	1.300	1.400	1.500	1.600	1.700	1.800
Höhe														
500	104,-	107,-	111,-	114,-	115,-	117,-	120,-	121,-	123,-	129,-	130,-	174,-	180,-	187,-
600	107,-	111,-	114,-	115,-	117,-	120,-	121,-	123,-	129,-	130,-	132,-	180,-	187,-	191,-
700	111,-	114,-	115,-	117,-	120,-	121,-	123,-	129,-	130,-	132,-	135,-	187,-	191,-	197,-
800	114,-	115,-	117,-	120,-	121,-	123,-	129,-	130,-	132,-	135,-	136,-	191,-	197,-	202,-
900	115,-	117,-	120,-	121,-	123,-	129,-	130,-	132,-	135,-	136,-	140,-	197,-	202,-	211,-
1.000	117,-	120,-	121,-	123,-	129,-	130,-	132,-	135,-	136,-	140,-	142,-	202,-	211,-	215,-
1.100	120,-	121,-	123,-	129,-	130,-	132,-	135,-	136,-	140,-	142,-	144,-	211,-	215,-	221,-
1.200	121,-	123,-	129,-	130,-	132,-	135,-	136,-	140,-	142,-	144,-	148,-	215,-	221,-	226,-
1.300	123,-	129,-	130,-	132,-	135,-	136,-	140,-	142,-	144,-	148,-	149,-	221,-	226,-	233,-
1.400	129,-	130,-	132,-	135,-	136,-	140,-	142,-	144,-	148,-	149,-	151,-	226,-	233,-	238,-
1.500	130,-	132,-	135,-	136,-	140,-	142,-	144,-	148,-	149,-	151,-	155,-	233,-	238,-	245,-
1.600	174,-	180,-	187,-	191,-	197,-	202,-	211,-	215,-	221,-	226,-	233,-	270,-	276,-	288,-
1.700	180,-	187,-	191,-	197,-	202,-	211,-	215,-	221,-	226,-	233,-	238,-	276,-	288,-	293,-
1.800	187,-	191,-	197,-	202,-	211,-	215,-	221,-	226,-	233,-	238,-	245,-	288,-	293,-	305,-
1.900	191,-	197,-	202,-	211,-	215,-	221,-	226,-	233,-	238,-	245,-	250,-	293,-	305,-	311,-
2.000	197,-	202,-	211,-	215,-	221,-	226,-	233,-	238,-	245,-	250,-	256,-	305,-	311,-	319,-
2.100	202,-	211,-	215,-	221,-	226,-	233,-	238,-	245,-	250,-	257,-	264,-	311,-	319,-	331,-
2.200	211,-	215,-	221,-	226,-	233,-	238,-	245,-	250,-	257,-	264,-	271,-	319,-	331,-	341,-
2.300	215,-	221,-	226,-	233,-	238,-	245,-	250,-	257,-	264,-	271,-	282,-	331,-	341,-	354,-
2.400	221,-	226,-	233,-	238,-	245,-	250,-	257,-	264,-	271,-	282,-	292,-	341,-	354,-	368,-
2.500	226,-	233,-	238,-	245,-	250,-	257,-	264,-	271,-	282,-	292,-	306,-	354,-	368,-	384,-
2.600	233,-	238,-	245,-	250,-	257,-	264,-	271,-	282,-	292,-	306,-	324,-	368,-	384,-	398,-

ab 1.500 mm mit Kämpfersprosse

ab 1.500 mm mit Kämpfersprosse

## 352.1-M Rahmenprofil-SD

Slim-Door

12mm Einbautiefe

mit Montageprofil (Aufpreis)

ohne Quersprosse (Aufpreis)

> auf Wunsch werden Montagebohrungen vorgebohrt.  
Bitte Befestigungsvariante angeben (F oder S)

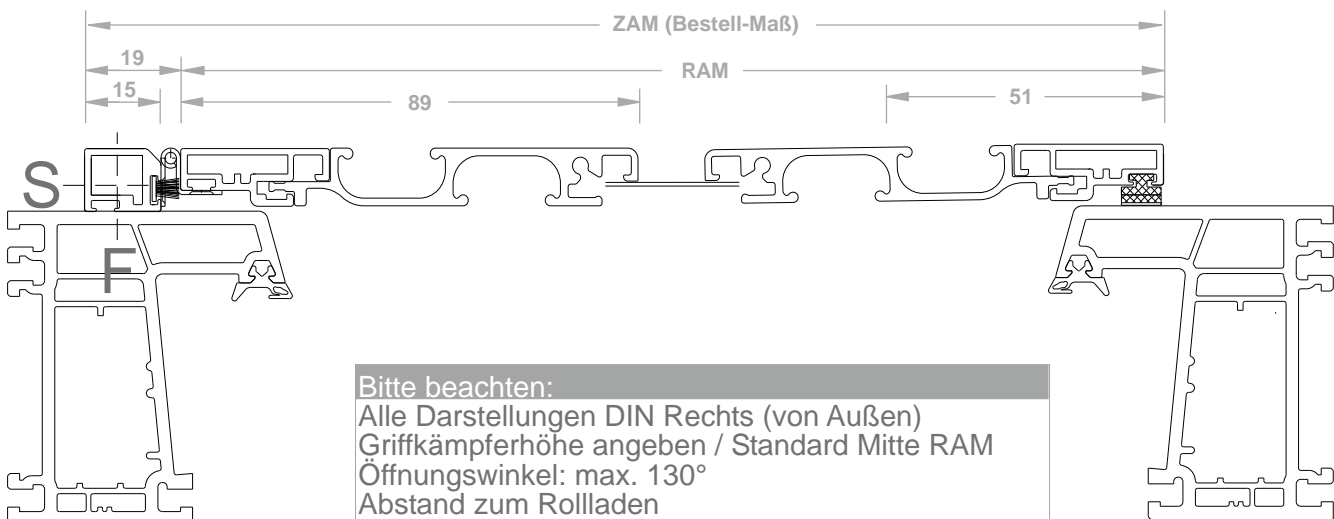
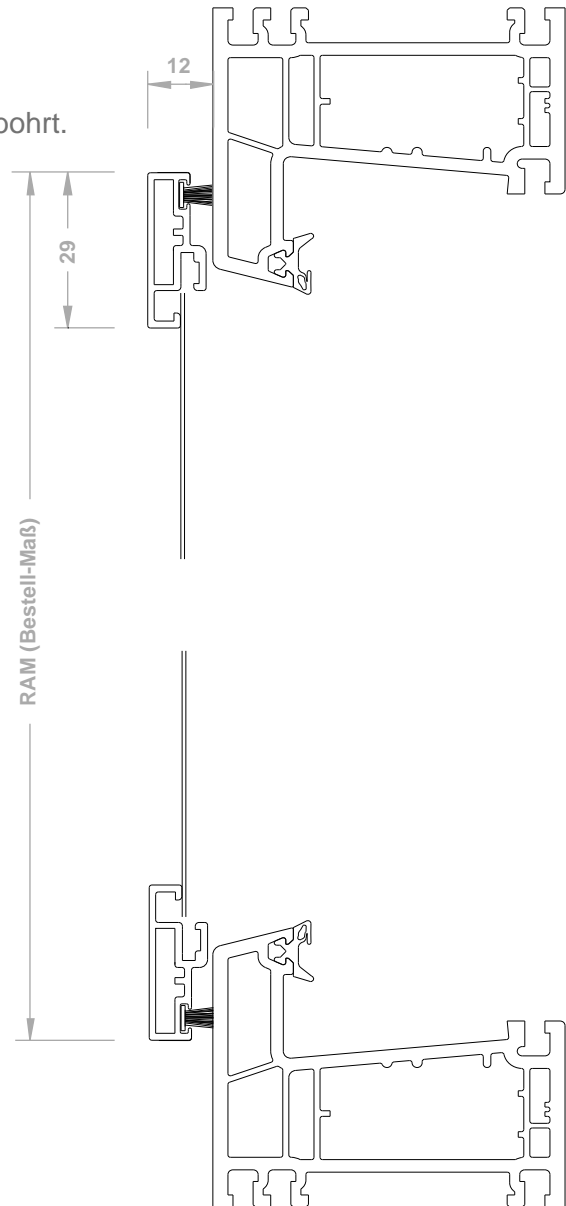
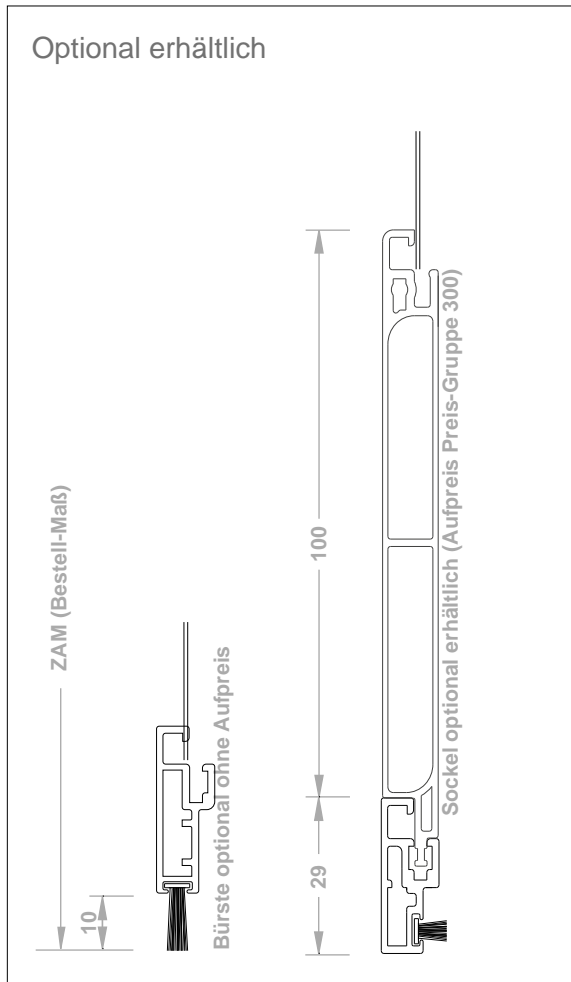
**Bitte beachten:**

Alle Darstellungen DIN Rechts (von Außen)  
Griffkämpferhöhe angeben / Standard Mitte RAM  
Öffnungswinkel: max. 130°  
Abstand zum Rollladen  
(Durchbiegung des Panzers)  
Bestellmaß: Zargenaußenmaß (ZAM)

**341 Rahmenprofil-D**

Dreh- und Magnetband

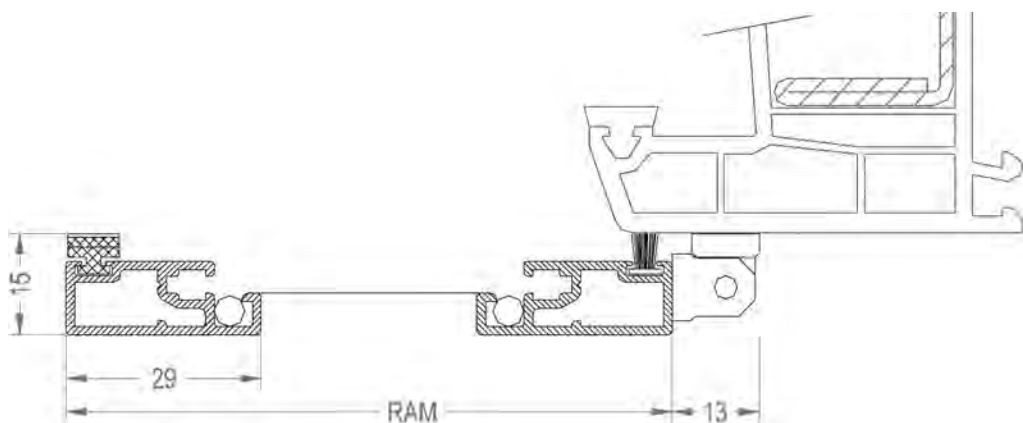

**351 Rahmenprofil-D**

Scharnier- und Magnetband

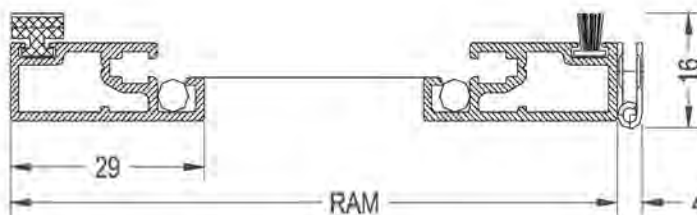

**353 Rahmenprofil-FD  
waagerechter Griffkämpfer**

Alu-Scharnier- und Magnetband

RAM = licht. BLR + 42 mm

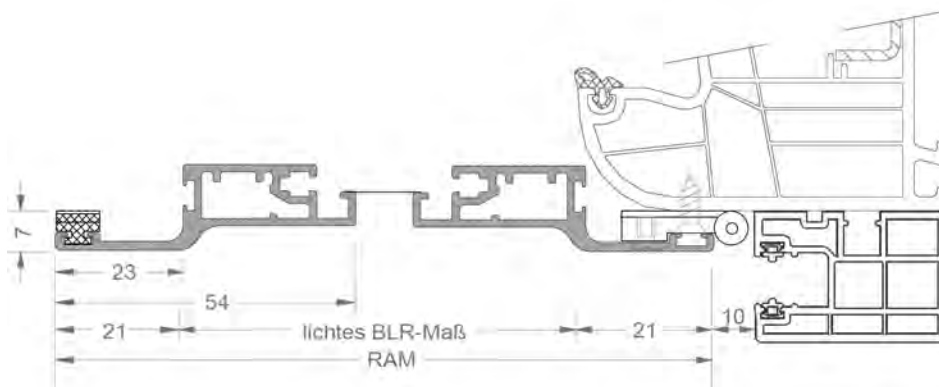

**361 Rahmenprofil-D**

Winkelscharnier sichtbar und Magnetband

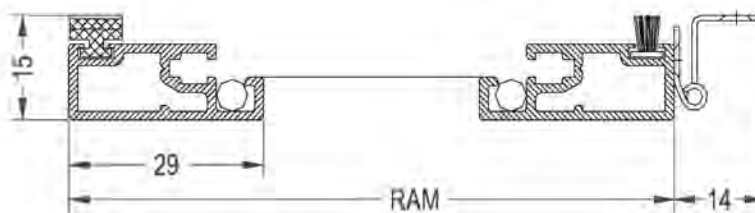

**366 Rahmenprofil-D**

Winkelscharnier verdeckt und Magnetband

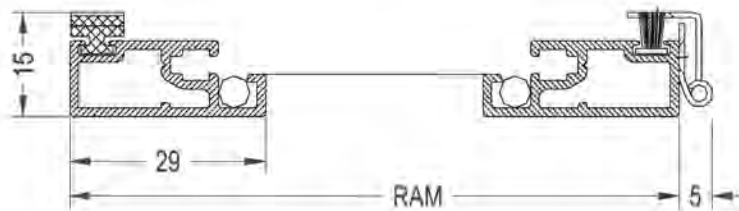

**Optional:**

**Drehtür Rahmenprofil-D ohne Quersprosse**

mit allen Beschlägen kombinierbar

Drehtür ohne Griffkämpfer/Quersprosse 40,00 €

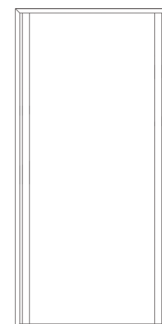



## Türen

Breite	700	800	900	1.000	1.100	1.200	1.300
Höhe							
1.900	231,-	237,-	241,-	249,-	254,-	262,-	266,-
2.000	237,-	241,-	249,-	254,-	262,-	266,-	271,-
2.100	241,-	249,-	254,-	262,-	266,-	271,-	276,-
2.200	249,-	254,-	262,-	266,-	271,-	276,-	284,-
2.300	254,-	262,-	266,-	271,-	276,-	284,-	290,-
2.400	262,-	266,-	271,-	276,-	284,-	290,-	296,-
2.500	268,-	274,-	281,-	287,-	293,-	298,-	305,-
2.600	281,-	287,-	291,-	297,-	307,-	309,-	316,-

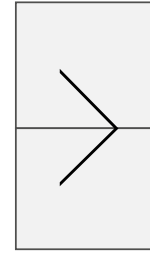

## 351-MC Rahmenprofil-D

Schanier- und  
Magnetband

mit Montageprofil

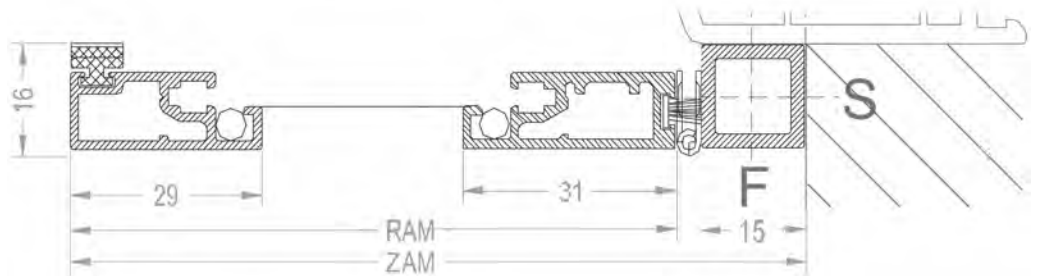

## Türen mit Montageprofil

Breite	700	800	900	1.000	1.100	1.200	1.300
Höhe							
1.900	258,-	264,-	268,-	276,-	281,-	289,-	293,-
2.000	264,-	268,-	276,-	281,-	289,-	293,-	298,-
2.100	268,-	276,-	281,-	289,-	293,-	298,-	303,-
2.200	276,-	281,-	289,-	293,-	298,-	303,-	311,-
2.300	281,-	289,-	293,-	298,-	303,-	311,-	317,-
2.400	289,-	293,-	298,-	303,-	311,-	317,-	323,-
2.500	296,-	301,-	308,-	314,-	320,-	325,-	332,-
2.600	308,-	314,-	318,-	324,-	334,-	336,-	343,-

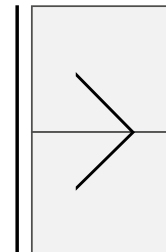

## Optional:

Trittschutz- / Sockel-Profil 100 mm	80,00 € / Flügel
Drehtür ohne Griffkämpfer/Querspasse	45,00 €
MS-5000 ISG Obentürschließer (lose)	69,- € / Flügel
Federbänder für Montageprofil	39,- € / Flügel
Stulpvariante B / Anschlagwinkel	27,- €

## Bitte angeben:

Beschlag  
DIN-Richtung (von aussen gesehen)  
Farbe  
Gewebeart  
Griffleistenhöhe (ohne Angabe - Mitte Tür)



Alle Türen können mit einer  
Abdichtung nach unten  
versehen werden.

**410**  
Schiebetür von links nach rechts  
mit umlaufender U-Schiene

**420**  
Schiebetür von rechts nach links  
mit umlaufender U-Schiene  
Zeichnung spiegelbildlich

**430**  
Schiebetür von links nach rechts  
3-seitig U-Schiene/unten 10/15 Alu E6/EV1

**440**  
Schiebetür von rechts nach links  
3-seitig U-Schiene/unten 10/15 Alu E6/EV1  
Zeichnung spiegelbildlich

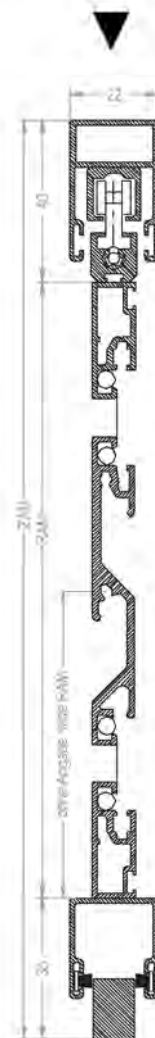
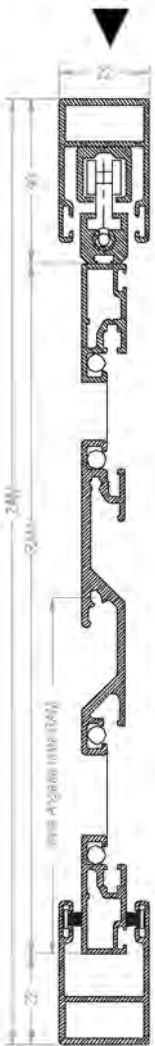

$$\text{RAM Breite} = \left( \frac{\text{ZAM}}{2} \right) - 5 \text{ mm}$$

RAM Höhe = ZAM - 62 mm  
Ohne Angabe Griffleiste  
Mitte Schiebeflügel

$$\text{RAM Breite} = \left( \frac{\text{ZAM}}{2} \right) - 5 \text{ mm}$$

RAM Höhe = ZAM - 75 mm  
Ohne Angabe Griffleiste  
Mitte Schiebeflügel

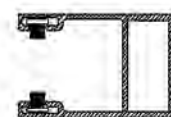
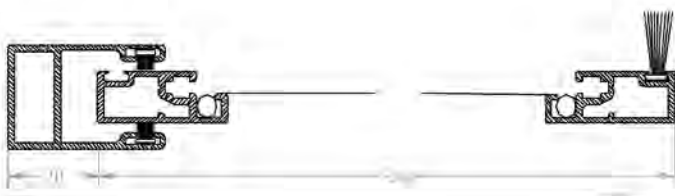



bis 1500 x 2300 mm Schiebeflügel

**411-D**  
Schiebetür von links nach rechts  
ohne Griffkämpfer  
mit umlaufender U-Schiene

**431-D**  
Schiebetür von links nach rechts  
ohne Griffkämpfer  
3-seitig U-Schiene/unten 10/15 Alu E6/EV1

**421-D**  
Schiebetür von rechts nach links  
ohne Griffkämpfer  
mit umlaufender U-Schiene  
Zeichnung spiegelbildlich

**440-D**  
Schiebetür von rechts nach links  
ohne Griffkämpfer  
3-seitig U-Schiene/unten 10/15 Alu E6/EV1  
Zeichnung spiegelbildlich



$$\text{RAM Breite} = \left( \frac{\text{ZAM}}{2} \right) - 5 \text{ mm}$$

$$\text{RAM Breite} = \left( \frac{\text{ZAM}}{2} \right) - 5 \text{ mm}$$

$$\text{RAM Höhe} = \text{ZAM} - 62 \text{ mm}$$

$$\text{RAM Höhe} = \text{ZAM} - 75 \text{ mm}$$

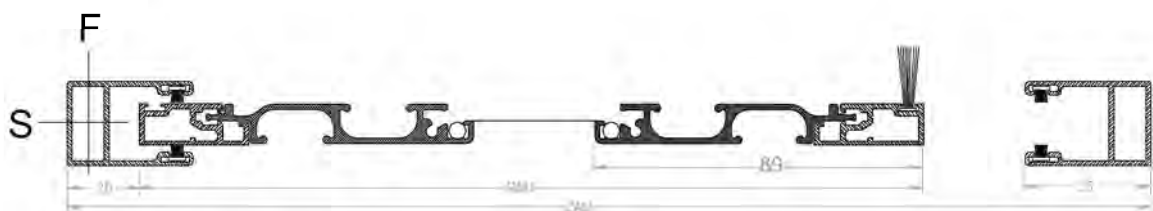



**447 Schiebetür**

Führung oben und unten quer  
mit waagrechttem Griffkämpfer

$$\text{RAM Breite} = \left(\frac{\text{ZAM}}{2}\right) + 30\text{mm}$$

$$\text{RAM Höhe} = \text{ZAM} - 65\text{mm}$$

**448 Schiebetür**

Führung oben und unten quer  
mit waagrechttem Griffkämpfer

$$\text{RAM Breite} = \left(\frac{\text{ZAM}}{2}\right) + 30\text{mm}$$

$$\text{RAM Höhe} = \text{ZAM} - 54\text{mm}$$

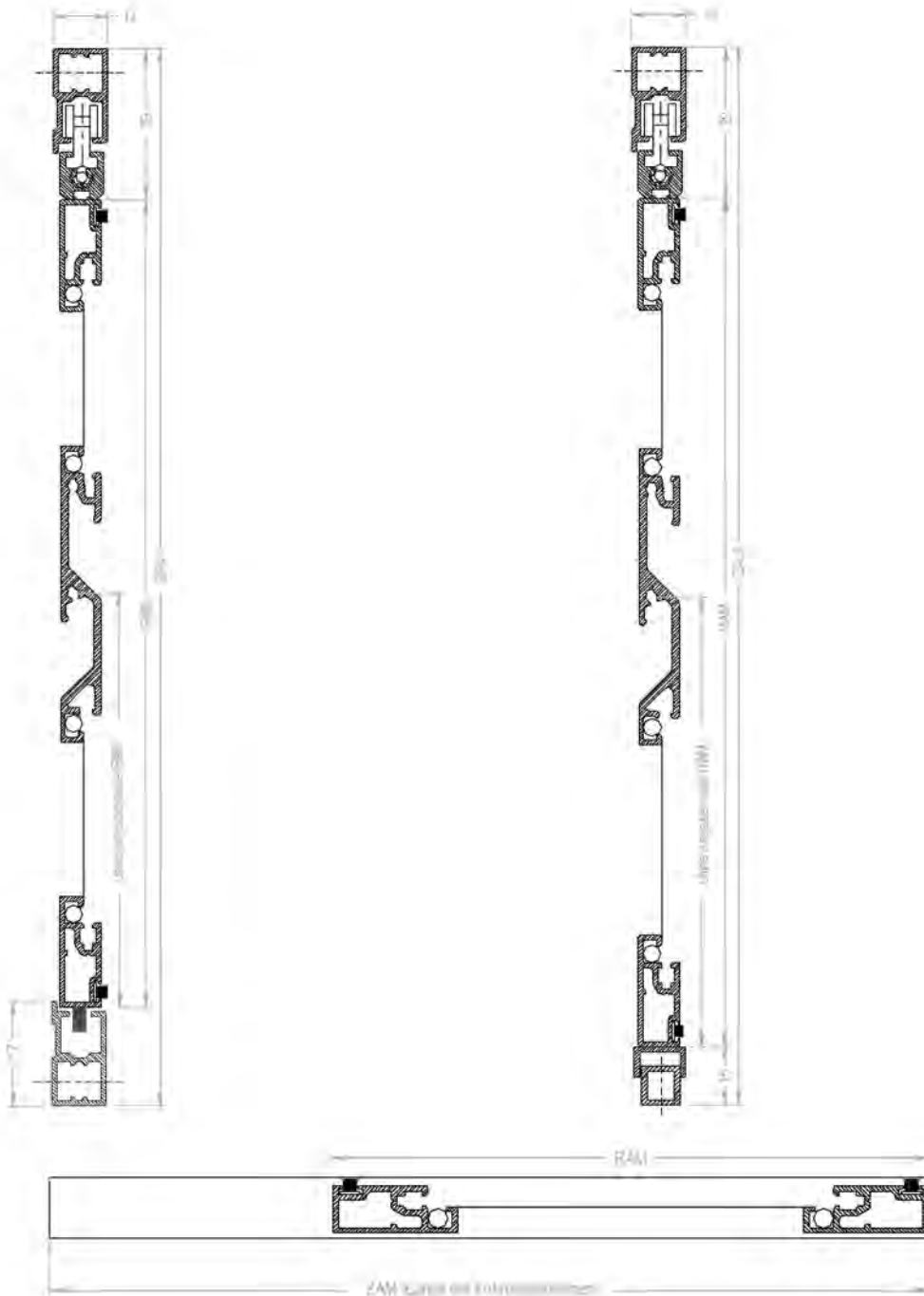

Bitte angeben ob die Führung von vorne vorgebohrt werden soll.  
Schiebeflügel auch ohne Griffkämpfer möglich.



### Einflügelige Schiebetür mit Quersprosse

Führung oben und unten



Breite	700	800	900	1.000	1.100	1.200	1.300	1.400	1.500	1.600	1.700	1.800	1.900	2.000
Höhe	Breite = RAM des Schiebeflügels (ZAM nicht berücksichtigen)													
1.900	355,-	368,-	380,-	395,-	408,-	421,-	434,-	446,-	460,-	505,-	517,-	530,-	543,-	555,-
2.000	368,-	380,-	395,-	408,-	421,-	434,-	446,-	460,-	472,-	517,-	530,-	543,-	555,-	568,-
2.100	380,-	395,-	408,-	421,-	434,-	446,-	460,-	472,-	485,-	530,-	543,-	555,-	568,-	581,-
2.200	395,-	408,-	421,-	434,-	446,-	460,-	472,-	485,-	500,-	546,-	559,-	573,-	588,-	601,-
2.300	408,-	421,-	434,-	446,-	460,-	472,-	485,-	500,-	511,-	557,-	572,-	586,-	600,-	615,-
2.400	421,-	434,-	446,-	460,-	472,-	485,-	500,-	511,-	524,-	571,-	584,-	598,-	614,-	627,-
2.500	434,-	446,-	460,-	472,-	485,-	500,-	511,-	524,-	537,-	583,-	597,-	613,-	626,-	640,-
2.600	452,-	465,-	477,-	491,-	505,-	519,-	531,-	543,-	556,-	602,-	617,-	630,-	645,-	659,-
2.700	477,-	489,-	504,-	517,-	529,-	546,-	555,-	568,-	581,-	628,-	641,-	656,-	669,-	684,-
2.800	508,-	521,-	535,-	547,-	560,-	578,-	586,-	598,-	613,-	658,-	673,-	687,-	701,-	715,-

ab 1.500 mm mit  
Kämpfersprosse

### Einflügelige Schiebetür - Griffleiste-I senkrecht

Führung oben und unten



Breite	700	800	900	1.000	1.100	1.200	1.300	1.400	1.500	1.600	1.700	1.800	1.900	2.000
Höhe	Breite = RAM des Schiebeflügels (ZAM nicht berücksichtigen)													
1.900	396,-	409,-	421,-	436,-	449,-	463,-	475,-	487,-	501,-	546,-	558,-	572,-	584,-	596,-
2.000	409,-	421,-	436,-	449,-	463,-	475,-	487,-	501,-	513,-	558,-	572,-	584,-	596,-	610,-
2.100	421,-	436,-	449,-	463,-	475,-	487,-	501,-	513,-	526,-	572,-	584,-	596,-	610,-	622,-
2.200	436,-	449,-	463,-	475,-	487,-	501,-	513,-	526,-	541,-	587,-	600,-	614,-	629,-	643,-
2.300	449,-	463,-	475,-	487,-	501,-	513,-	526,-	541,-	552,-	598,-	613,-	627,-	641,-	656,-
2.400	463,-	475,-	487,-	501,-	513,-	526,-	541,-	552,-	565,-	612,-	625,-	639,-	655,-	668,-
2.500	475,-	487,-	501,-	513,-	526,-	541,-	552,-	565,-	578,-	624,-	638,-	654,-	667,-	682,-
2.600	493,-	506,-	518,-	533,-	546,-	560,-	573,-	584,-	597,-	644,-	658,-	671,-	686,-	700,-
2.700	518,-	530,-	545,-	558,-	571,-	587,-	596,-	610,-	622,-	669,-	683,-	697,-	710,-	725,-
2.800	549,-	562,-	576,-	588,-	601,-	619,-	627,-	639,-	654,-	699,-	714,-	728,-	742,-	757,-

ab 1.500 mm mit  
Kämpfersprosse

## Einflügelige Schiebetür mit Quersprosse

Führung umlaufend

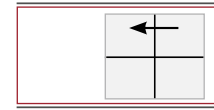
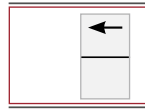

Breite	700	800	900	1.000	1.100	1.200	1.300	1.400	1.500	1.600	1.700	1.800	1.900	2.000
Höhe	Breite = RAM des Schiebeflügels (ZAM nicht berücksichtigen)													
1.900	389,-	404,-	417,-	433,-	448,-	462,-	476,-	490,-	504,-	554,-	567,-	582,-	596,-	609,-
2.000	404,-	417,-	433,-	448,-	462,-	476,-	490,-	504,-	518,-	567,-	582,-	596,-	609,-	624,-
2.100	417,-	433,-	448,-	462,-	476,-	490,-	504,-	518,-	532,-	582,-	596,-	609,-	624,-	637,-
2.200	433,-	448,-	462,-	476,-	490,-	504,-	518,-	532,-	548,-	599,-	614,-	628,-	645,-	660,-
2.300	448,-	462,-	476,-	490,-	504,-	518,-	532,-	548,-	561,-	611,-	627,-	643,-	659,-	675,-
2.400	462,-	476,-	490,-	504,-	518,-	532,-	548,-	561,-	575,-	626,-	641,-	656,-	673,-	688,-
2.500	476,-	490,-	504,-	518,-	532,-	548,-	561,-	575,-	589,-	640,-	655,-	672,-	687,-	703,-
2.600	496,-	510,-	523,-	539,-	554,-	570,-	583,-	596,-	610,-	661,-	677,-	691,-	707,-	723,-
2.700	523,-	537,-	553,-	567,-	581,-	599,-	609,-	624,-	637,-	689,-	704,-	720,-	734,-	750,-
2.800	557,-	572,-	587,-	600,-	615,-	634,-	643,-	656,-	672,-	722,-	739,-	754,-	769,-	785,-

ab 1.500 mm mit  
Kämpfersprosse

## Einflügelige Schiebetür - Griffleiste-I senkrecht

Führung umlaufend

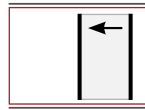

Breite	700	800	900	1.000	1.100	1.200	1.300	1.400	1.500	1.600	1.700	1.800	1.900	2.000
Höhe	Breite = RAM des Schiebeflügels (ZAM nicht berücksichtigen)													
1.900	434,-	449,-	462,-	478,-	493,-	508,-	521,-	535,-	549,-	599,-	613,-	627,-	641,-	654,-
2.000	449,-	462,-	478,-	493,-	508,-	521,-	535,-	549,-	563,-	613,-	627,-	641,-	654,-	669,-
2.100	462,-	478,-	493,-	508,-	521,-	535,-	549,-	563,-	578,-	627,-	641,-	654,-	669,-	682,-
2.200	478,-	493,-	508,-	521,-	535,-	549,-	563,-	578,-	593,-	644,-	659,-	673,-	690,-	705,-
2.300	493,-	508,-	521,-	535,-	549,-	563,-	578,-	593,-	606,-	656,-	672,-	688,-	704,-	720,-
2.400	508,-	521,-	535,-	549,-	563,-	578,-	593,-	606,-	620,-	671,-	686,-	702,-	719,-	733,-
2.500	521,-	535,-	549,-	563,-	578,-	593,-	606,-	620,-	634,-	685,-	700,-	717,-	732,-	748,-
2.600	541,-	555,-	569,-	584,-	599,-	615,-	628,-	641,-	655,-	706,-	722,-	737,-	752,-	768,-
2.700	569,-	582,-	598,-	613,-	626,-	644,-	654,-	669,-	682,-	734,-	749,-	765,-	779,-	795,-
2.800	602,-	617,-	632,-	645,-	660,-	679,-	688,-	702,-	717,-	767,-	784,-	799,-	814,-	830,-

ab 1.500 mm mit  
Kämpfersprosse

## 447.1 - ZERO-Slide ohne Quersprosse

- > inkl. 2 Endstopper
- > auf Wunsch werden Montagebohrungen vorgebohrt.  
Bitte Befestigungsvariante angeben (F oder S)

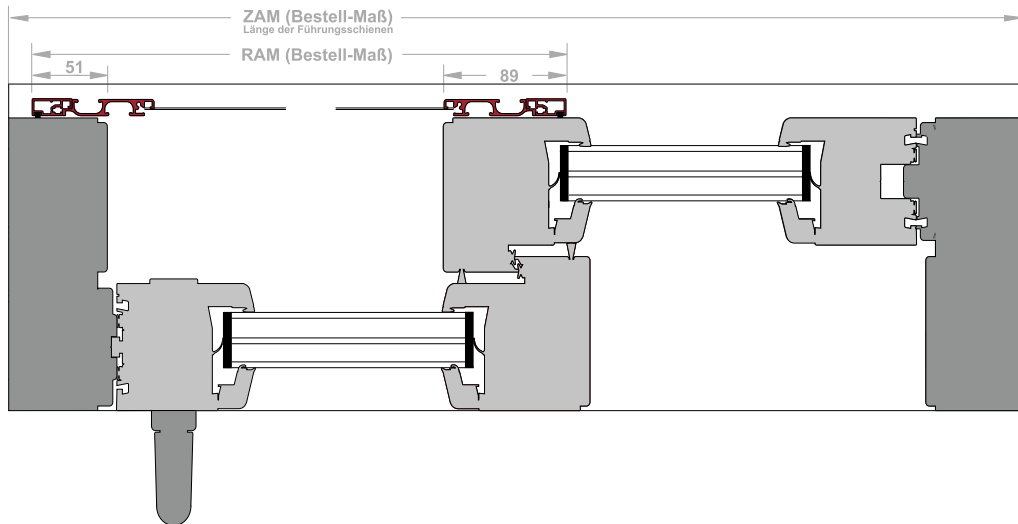
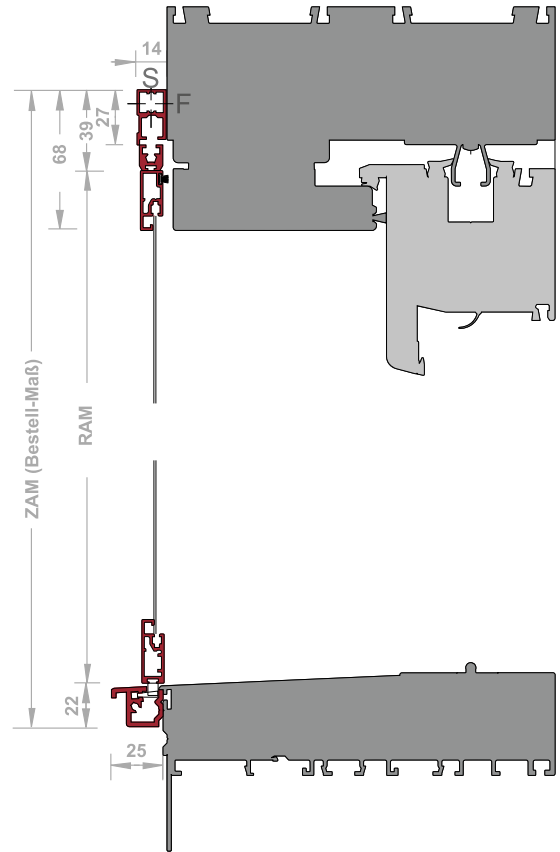

### Profilübersicht

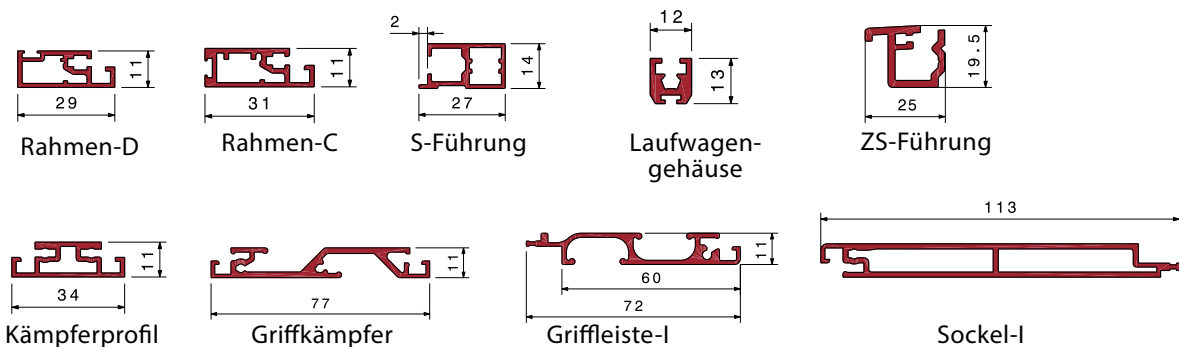





**650 Zarge umlaufend,  
Tür öffnet nach außen**

RAM = ZAM -37mm

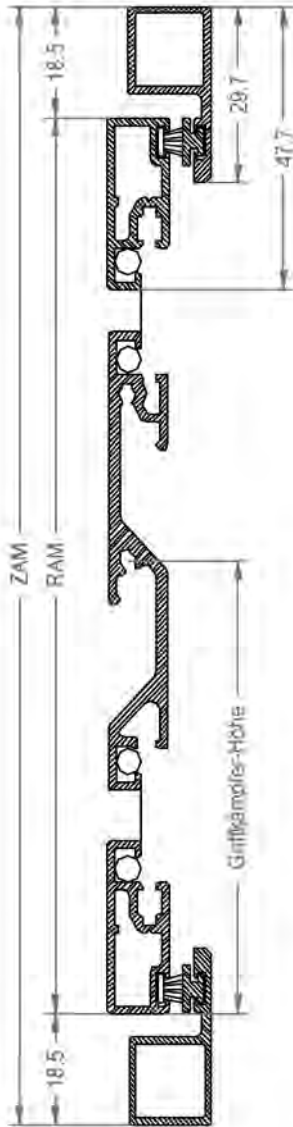

**652 Zarge 3 seitig  
Tür öffnet nach außen**

RAM = ZAM -29mm

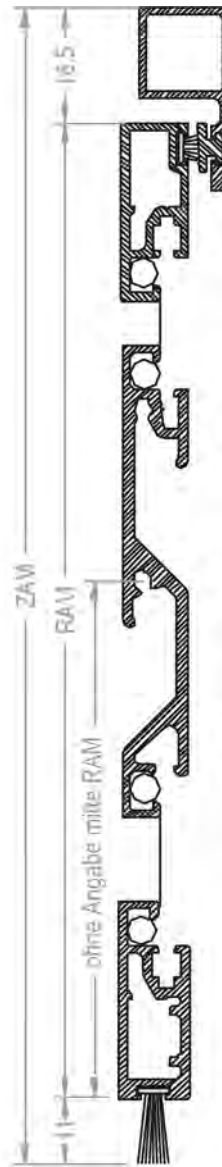

**Darstellung DIN R**

RAM = ZAM -37mm

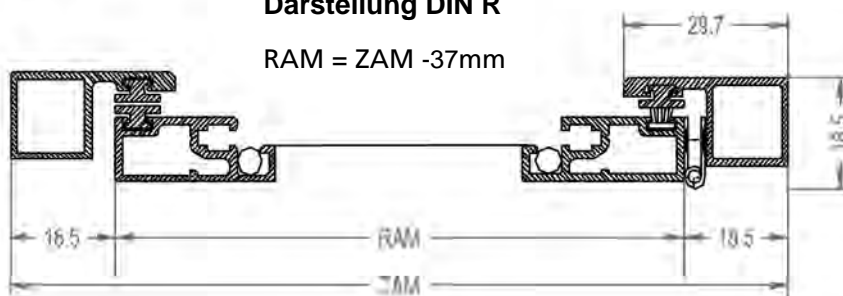

## Tür mit Zarge ohne Sockel

Breite	700	800	900	1.000	1.100	1.200	1.300
Höhe							
1.900	346,-	355,-	364,-	372,-	382,-	390,-	399,-
2.000	355,-	364,-	372,-	382,-	390,-	399,-	408,-
2.100	364,-	372,-	382,-	390,-	399,-	408,-	416,-
2.200	372,-	382,-	390,-	399,-	408,-	416,-	426,-
2.300	382,-	390,-	399,-	408,-	416,-	426,-	435,-
2.400	390,-	399,-	408,-	416,-	426,-	435,-	443,-
2.500	407,-	414,-	422,-	431,-	441,-	450,-	460,-
2.600	428,-	434,-	441,-	451,-	464,-	468,-	482,-

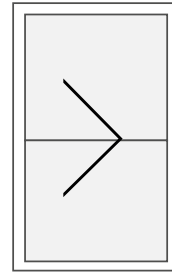

## Tür mit Zarge und Sockel

Breite	700	800	900	1.000	1.100	1.200	1.300
Höhe							
1.900	431,-	440,-	450,-	457,-	467,-	476,-	484,-
2.000	440,-	450,-	457,-	467,-	476,-	484,-	493,-
2.100	450,-	457,-	467,-	476,-	484,-	493,-	502,-
2.200	457,-	467,-	476,-	484,-	493,-	502,-	513,-
2.300	467,-	476,-	484,-	493,-	502,-	513,-	520,-
2.400	476,-	484,-	493,-	502,-	513,-	520,-	530,-
2.500	492,-	500,-	506,-	517,-	527,-	535,-	545,-
2.600	514,-	519,-	527,-	536,-	548,-	554,-	567,-

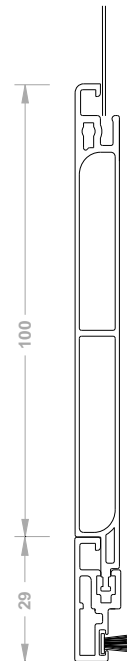
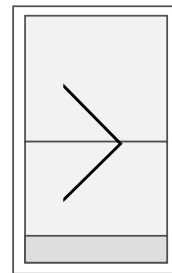

### Optional:

Drehtür ohne Griffkämpfer/Quersprosse 45,00 €  
 Federbänder 39,00 €

### Bitte angeben:

Beschlag  
 DIN-Richtung (von aussen gesehen)  
 Farbe  
 Gewebeart  
 Griffleistenhöhe (ohne Angabe - Mitte Tür)

Zargen können vorgebohrt geliefert werden.  
 Bitte Montageart angeben (S oder F).  
 S = seitlich  
 F = Frontal



### 710 Fensterrollo

„Klick-Klack“ Verschluss  
 Endraster variabel einstellbar  
 mit 2,5 mm Innen 6-Kant

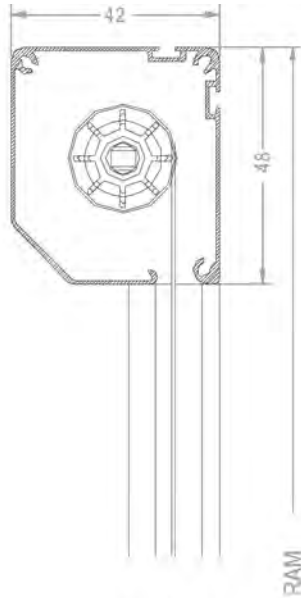

Größen:  
 min. 500 x 500 mm  
 max. 1500 x 1800 mm

Montagevariante  
 mit KS-Montagewinkeln  
 weiss oder schwarz sind  
 im Lieferumfang enthalten.

Führungsschienen können vorgebohrt  
 geliefert werden. Bitte Montageart  
 angeben (S oder F).

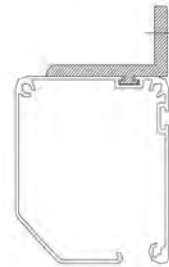
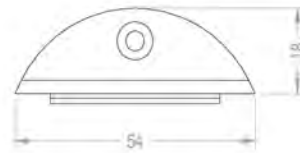

### 710-B

Optional mit Abdichtung  
 zum Blendrahmen  
 Bitte bei Bestellung angeben

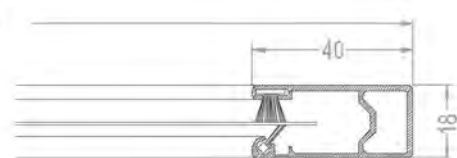
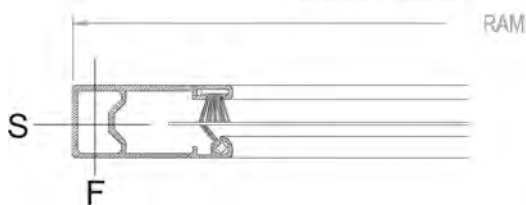
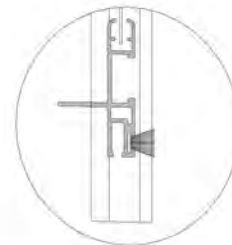



**Fenster-Rollo**

Breite	600	700	800	900	1.000	1.100	1.200	1.300	1.400	1.500
Höhe										
600	173,-	186,-	195,-	204,-	214,-	222,-	229,-	239,-	248,-	254,-
700	182,-	188,-	197,-	211,-	218,-	226,-	236,-	241,-	250,-	259,-
800	186,-	194,-	201,-	213,-	221,-	229,-	238,-	247,-	254,-	263,-
900	190,-	197,-	204,-	217,-	224,-	235,-	241,-	249,-	257,-	266,-
1.000	195,-	201,-	211,-	221,-	229,-	237,-	245,-	253,-	263,-	270,-
1.100	199,-	204,-	214,-	224,-	233,-	240,-	249,-	257,-	265,-	273,-
1.200	211,-	217,-	226,-	238,-	247,-	254,-	265,-	273,-	283,-	291,-
1.300	213,-	222,-	229,-	241,-	250,-	259,-	267,-	276,-	287,-	296,-
1.400	217,-	226,-	236,-	247,-	254,-	264,-	271,-	281,-	290,-	298,-
1.500	222,-	231,-	239,-	250,-	259,-	267,-	275,-			
1.600	235,-	243,-	252,-	266,-	275,-	287,-	293,-			
1.700	238,-	248,-	256,-	270,-	281,-	290,-	298,-			
1.800	241,-	252,-	263,-	274,-	284,-	296,-	302,-			

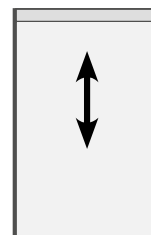

**Aufpreis für**

Beschichtung RAL nach Wahl  
Folierung (Renolit)

35%  
auf Anfrage

**Fenster-Rollo geschlossener Rahmen**

Breite	600	700	800	900	1.000	1.100	1.200	1.300	1.400	1.500
Höhe										
600	199,-	212,-	221,-	230,-	240,-	248,-	255,-	265,-	274,-	280,-
700	208,-	214,-	223,-	237,-	244,-	252,-	262,-	267,-	276,-	285,-
800	212,-	220,-	227,-	239,-	247,-	255,-	264,-	273,-	280,-	289,-
900	215,-	223,-	230,-	243,-	250,-	261,-	267,-	275,-	283,-	292,-
1.000	221,-	227,-	237,-	247,-	255,-	263,-	271,-	279,-	289,-	296,-
1.100	224,-	230,-	240,-	250,-	259,-	266,-	275,-	283,-	291,-	299,-
1.200	237,-	243,-	252,-	264,-	273,-	280,-	291,-	299,-	309,-	317,-
1.300	239,-	248,-	255,-	267,-	276,-	285,-	293,-	302,-	312,-	321,-
1.400	243,-	252,-	262,-	273,-	280,-	290,-	297,-	307,-	316,-	324,-
1.500	248,-	257,-	265,-	276,-	285,-	293,-	301,-			
1.600	261,-	268,-	277,-	292,-	301,-	312,-	319,-			
1.700	264,-	274,-	282,-	296,-	307,-	316,-	324,-			
1.800	267,-	277,-	289,-	300,-	310,-	321,-	328,-			

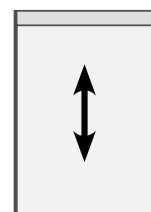

**Aufpreis für**

Beschichtung RAL nach Wahl  
Folierung (Renolit)

35%  
auf Anfrage



Abdichtung nach unten

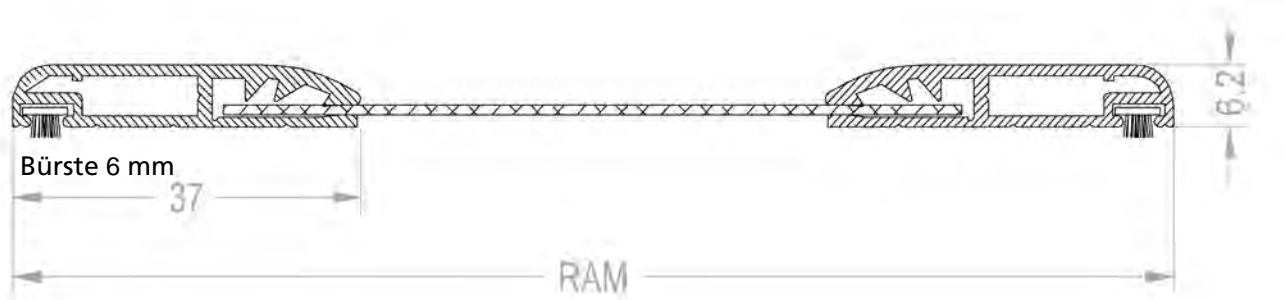

**Befestigungsvariante 1**  
Butyl Dichtband

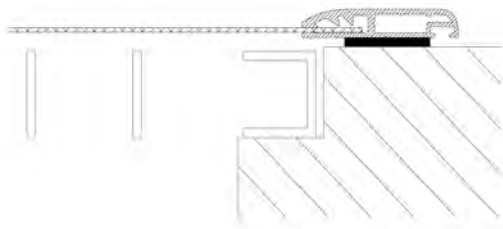

**Befestigungsvariante 2**  
Klemmutter



Breite	400	500	600	700	800	900	1.000	1.100	1.200	1.300	1.400	1.500	1.600	1.700	1.800	1.900	2.000	
Höhe																		
300	89,-	95,-	100,-	106,-	114,-	118,-	123,-	130,-	136,-	142,-	148,-	153,-	160,-	167,-	171,-	177,-	184,-	
400	96,-	103,-	111,-	116,-	122,-	130,-	136,-	144,-	150,-	157,-	164,-	170,-	177,-	185,-	191,-	199,-	204,-	
500	103,-	111,-	118,-	124,-	134,-	141,-	149,-	156,-	165,-	171,-	180,-	187,-	196,-	202,-	212,-	218,-	226,-	
600	111,-	118,-	127,-	135,-	144,-	151,-	162,-	170,-	178,-	187,-	196,-	203,-	214,-	222,-	231,-	239,-	248,-	
700	116,-	124,-	135,-	146,-	155,-	164,-	173,-	184,-	194,-	202,-	213,-	222,-	231,-	240,-	250,-	262,-	270,-	
800	122,-	134,-	144,-	155,-	165,-	175,-	186,-	197,-	208,-	218,-	228,-	239,-	249,-	259,-	270,-	281,-	291,-	
900	130,-	141,-	151,-	164,-	175,-	187,-	199,-	211,-	221,-	233,-	245,-	256,-	267,-	279,-	290,-	301,-	314,-	
1.000	136,-	149,-	162,-	173,-	186,-	199,-	212,-	223,-	236,-	248,-	262,-	273,-	284,-	297,-	309,-	321,-	335,-	
1.100	144,-	156,-	170,-	184,-	197,-	211,-	223,-	237,-	250,-	264,-	275,-	290,-	302,-	317,-	331,-	343,-	356,-	
1.200	150,-	165,-	178,-	194,-	208,-	221,-	236,-	250,-	265,-	279,-	292,-	307,-	320,-	335,-	349,-	363,-	377,-	
1.300	157,-	171,-	187,-	202,-	218,-	233,-	248,-	264,-	279,-	292,-	308,-	323,-	340,-	354,-	369,-	385,-	399,-	

Lichtschachtabdeckung lieferbar mit den  
Oberflächen:  
EV1 farblos eloxiert

Gewebe:  
Begehbare Edelstahl-Gewebe  
Befahrbares Steckmetall Alu silber eloxiert 140,00 € / m<sup>2</sup>

mit mind. einer seitlichen Bürste

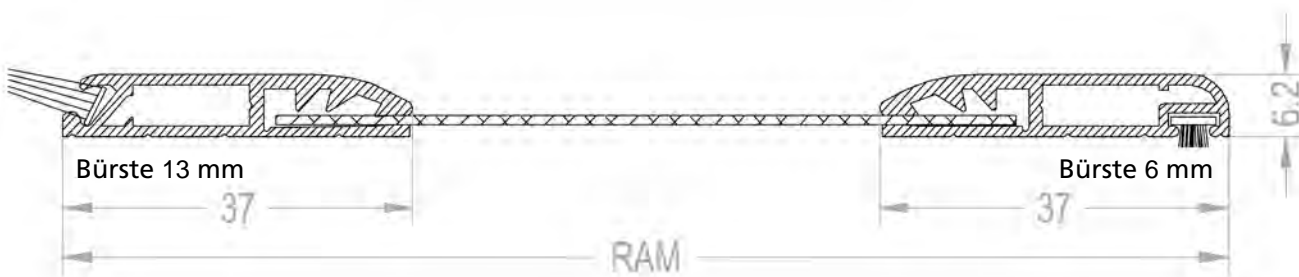

**Befestigungsvariante 1**  
Butyl Dichtband

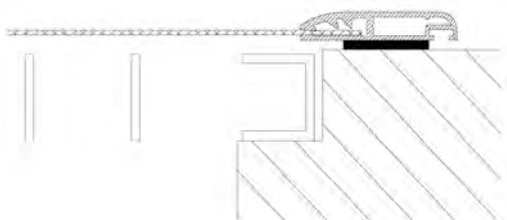

**Befestigungsvariante 2**  
Klemmutter

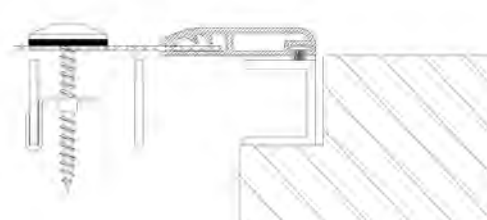

Bitte Bürstenseite(n)  
angeben

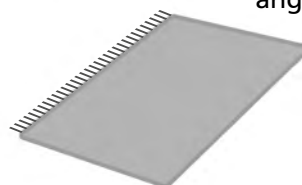

Breite	400	500	600	700	800	900	1.000	1.100	1.200	1.300	1.400	1.500	1.600	1.700	1.800	1.900	2.000	
Höhe																		
300	96,-	102,-	107,-	115,-	121,-	127,-	134,-	140,-	147,-	151,-	160,-	165,-	171,-	177,-	185,-	190,-	197,-	
400	103,-	111,-	117,-	123,-	132,-	140,-	147,-	153,-	162,-	169,-	175,-	184,-	190,-	199,-	204,-	213,-	220,-	
500	111,-	118,-	127,-	135,-	144,-	151,-	161,-	168,-	175,-	185,-	194,-	201,-	211,-	218,-	226,-	236,-	243,-	
600	117,-	127,-	136,-	146,-	155,-	164,-	173,-	184,-	191,-	201,-	211,-	220,-	229,-	238,-	248,-	256,-	266,-	
700	123,-	135,-	146,-	155,-	167,-	175,-	186,-	197,-	208,-	217,-	228,-	238,-	248,-	259,-	268,-	279,-	290,-	
800	132,-	144,-	155,-	167,-	177,-	188,-	200,-	212,-	222,-	235,-	245,-	256,-	267,-	279,-	290,-	301,-	314,-	
900	140,-	151,-	164,-	175,-	188,-	201,-	213,-	224,-	238,-	250,-	263,-	274,-	288,-	300,-	311,-	323,-	336,-	
1.000	147,-	161,-	173,-	186,-	200,-	213,-	226,-	239,-	253,-	266,-	279,-	292,-	306,-	319,-	333,-	346,-	359,-	
1.100	153,-	168,-	184,-	197,-	212,-	224,-	239,-	253,-	267,-	283,-	297,-	311,-	324,-	340,-	355,-	369,-	384,-	
1.200	162,-	175,-	191,-	208,-	222,-	238,-	253,-	267,-	283,-	298,-	315,-	331,-	345,-	360,-	373,-	389,-	406,-	
1.300	169,-	185,-	201,-	217,-	235,-	250,-	266,-	283,-	298,-	316,-	332,-	347,-	363,-	381,-	396,-	413,-	430,-	

Lichtschachtdeckung lieferbar mit den Oberflächen:  
EV1 farblos eloxiert

Gewebe:  
Begehbare Edelstahl-Gewebe  
Befahrbares Steckmetall Alu silber eloxiert 140,00 € / m<sup>2</sup>

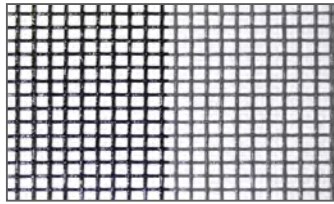
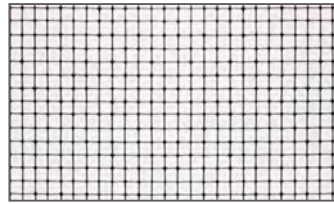
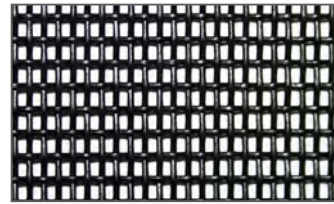
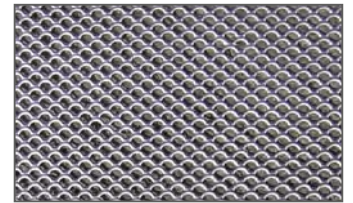

## Gewebesorten:

Fiberglas (Standard) 8,00 €/ m<sup>2</sup>T+ Gewebe 22,00 €/ m<sup>2</sup>PET-Screen 40,- €/ m<sup>2</sup>Aluminium 45,- €/ m<sup>2</sup>Edelstahl 70,- €/ m<sup>2</sup>Pollenschutz 100,- €/ m<sup>2</sup>LISA Edelstahl 100,- €/ m<sup>2</sup>LISA Steckmetall 140,00 €/ m<sup>2</sup>

## Sonderkonstruktionen:

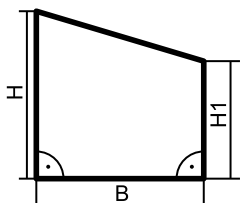
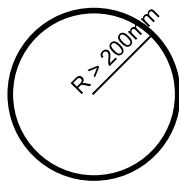
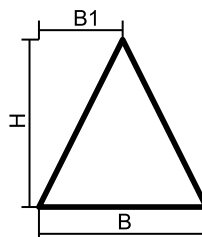
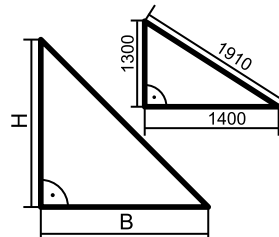
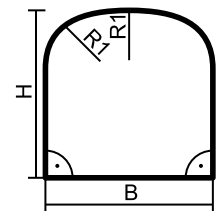
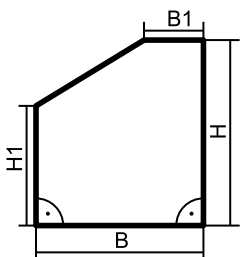
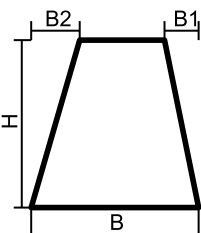
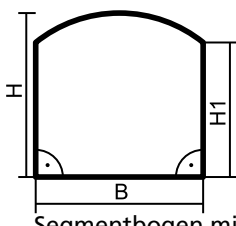
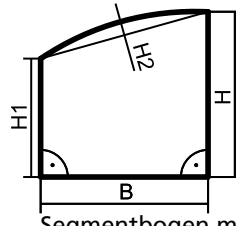
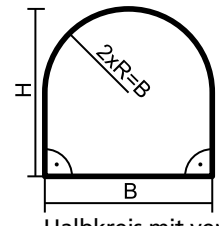
1 schräge Kante  
Aufpreis 110,- €Kreis  
Aufpreis 250,- €Dreieck  
Aufpreis 165,- €Dreieck  
Aufpreis 110,- €Korbbogen mit verlängerten  
Schenkeln (max. 5,8 mtr.)  
Aufpreis 400,- €Vieleck  
Aufpreis 110,- €Trapez  
Aufpreis 220,- €Segmentbogen mit  
Stichhöhe  
Aufpreis 135,- €Segmentbogen mit  
Stichhöhe  
Aufpreis 135,- €Halbkreis mit verlängerten  
Schenkeln (max. 5,8 mtr.)  
Aufpreis 250,- €

**Preisermittlung:** Umschreibendes Rechteck + Aufschlag. Bei Modellen kann ein Kämpfer erforderlich sein, wenn das Element < 1500 mm ist. Dies gilt besonders bei rechtwinkligen Dreiecken.  
**Nicht aufgeführte Modelle auf Anfrage.**

## Farben &amp; Folierung:

RAL 9016 weiss ohne Aufpreis

RAL 9006 weißalu matt ohne Aufpreis

RAL 7016 (matt) ohne Aufpreis

RAL DB 703 ohne Aufpreis

RAL nach Wahl + 35%

RAL 8001 (matt) ohne Aufpreis

RAL 8017 (matt) ohne Aufpreis

RAL 8022 (matt) ohne Aufpreis

Golden Oak + Mahagoni + 45%

Sonstige Folierungen auf Anfrage.

⚠ Die abgebildeten Farben können von den Originalfarben abweichen.





**Drehband mit loseem Stift**

Ausführung:  
Kunststoff / V2A  
weiß / schwarz / grau  
**Preis: 4,80 € / Stück**



**Laufwagen Schiebetür**

**Preis: 6,00 € / Stück**  
**Stopper für Laufwagen**  
**Preis: 8,00 € / Stück**



**Edelstahlscharnier mit loseem Stift**

**Preis: 3,80 € / Stück**



**DG-Griff für Drehtüren**

Ausführung: 15 x 125 mm  
Seitenkappen schwarz

RAL 9016	RAL 8022 matt
RAL 7016 matt	RAL 9005 matt
RAL 8001 matt	RAL 9006 matt
RAL 8017 matt	DB703 matt

**Preis: 15,00 € / Stück**



**Edelstahlwinkel-scharnier SD mit loseem Stift**

**Preis: 3,80 € / Stück**



**SG-Griff für Schiebetüren**

schwarz (EPDM)  
flach: SG-F  
rund: SG-R

**Preis: 7,50 € / Stück**



**Federschließer**

Ausführung:  
weiß  
braun  
silber  
**Preis: 25,00 € / Stück**

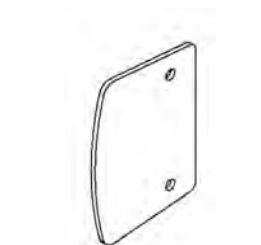

**Ziehgriff aus Aluminium**

Bautiefe: 2 mm  
+ Schraubenkopf  
RAL 9016  
RAL 7016 matt  
RAL 9005 matt  
RAL 9006 matt

**Preis: 8,90 € / Stück**



**ISG-Obentürschließer MS-5000**

Bautiefe 15 mm  
RAL 9016  
RAL 7016 matt  
RAL 8001 matt  
RAL 8017 matt  
RAL 8022 matt  
RAL 9005 matt  
RAL 9006 matt  
DB703 matt

**Preis: 69,00 € / Stück**

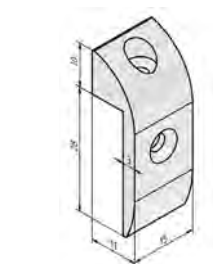

**Abroller für Rollladenpanzer schwarz (EPDM)**

**Preis: 3,00 € / Stück**



**Bürste grau: 3 / 4 / 5 / 6 / 7 / 10 / 11 / 13 / 18 mm**

schwarz: 10 / 13 mm  
selbstklebend: 11 mm  
**Preis: 4,00 € / Meter**

**Bürste grau: 28 mm**  
**Preis: 8,00 € / Meter**



## Plissee P20

- » Für Fenster, Türen, Schiebetüren und Dachflächenfenster geeignet
- » Kinderleichte Bedienung
- » Nur 20 mm Einbautiefe
- » Einflügelig bis 2.800 x 2.800 mm
- » Rahmen umlaufend 32 mm
- » Flache Bodenschiene 10 mm
- » Flache Bodenschiene für gerade und 5° schräge Türschwellen geeignet
- » Großzügige integrierte Griffnut
- » optional mit umlaufender Bürste zum Mauerwerk
- » Montage auf oder in der Laibung möglich (vorgebohrt)
- » alternativ komplett schraublos zum Einclippen mit unserem beliebten EASY<sup>2</sup>-Beschlag
- » Ruhiger Lauf (ohne Kette)
- » Einzigartige wettergeschützte Schnurführung
- » Lieferbar in 7 Standard-Farben und sämtlichen RAL-Sonderfarben
- » Made in Germany

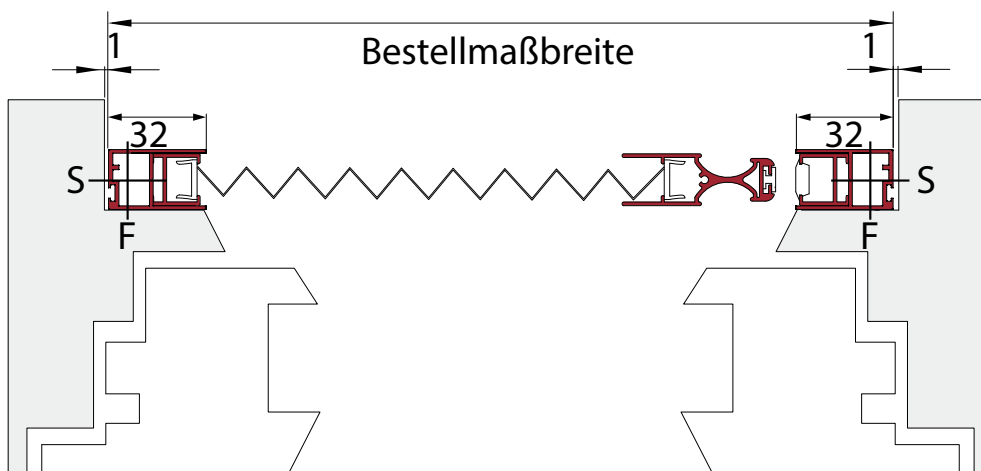

» Griff (optional)



» Montagevideos

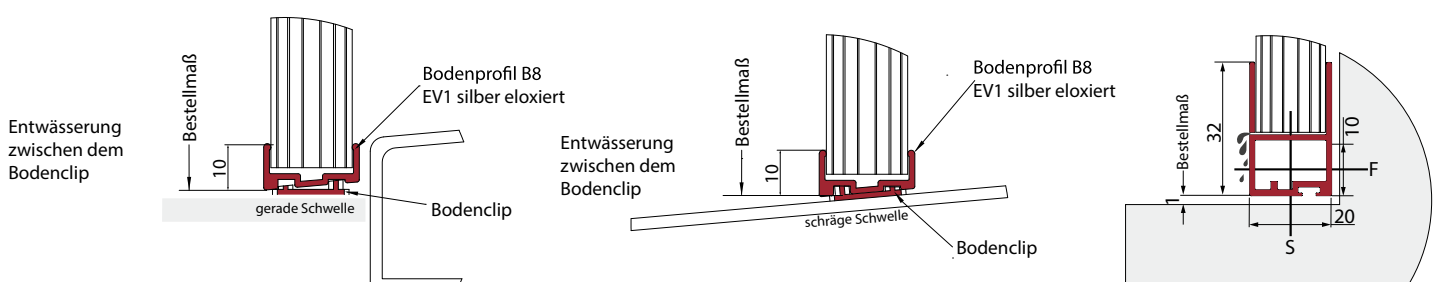

## P20 - 230 R4

Plissee mit EASY<sup>2</sup> - Beschlag  
 Rahmenprofil-R32 mit 10mm Bürste umlaufend  
 Gesamtstärke 25mm

P20 - 230 R4 R (Gewebepaket rechts von aussen) max. 1600 x 2200 mm

P20 - 230 R4 L (Gewebepaket links von aussen) max. 1600 x 2200 mm

P20 - 230 R4 O (Gewebepaket oben) max. 1600 x 2000 mm

P20 - 230 R4 U (Gewebepaket unten) max. 1600 x 2000 mm

RAM Breite = licht. BLR - 5mm

RAM Höhe = licht. BLR - 5mm

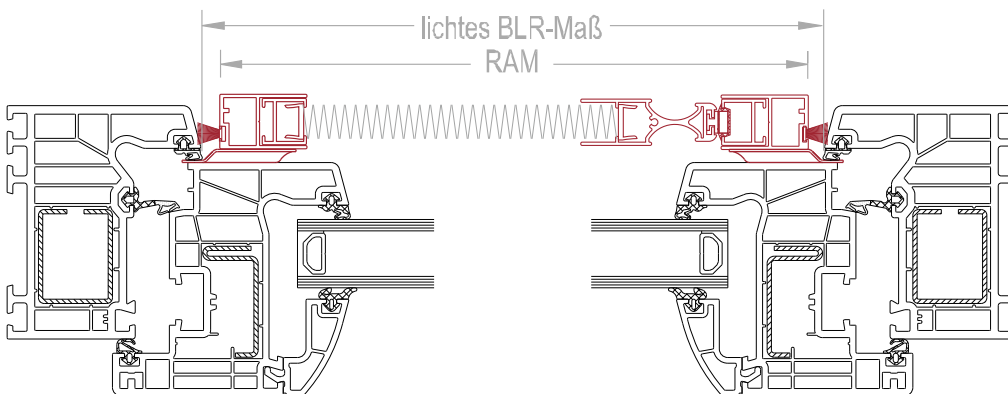
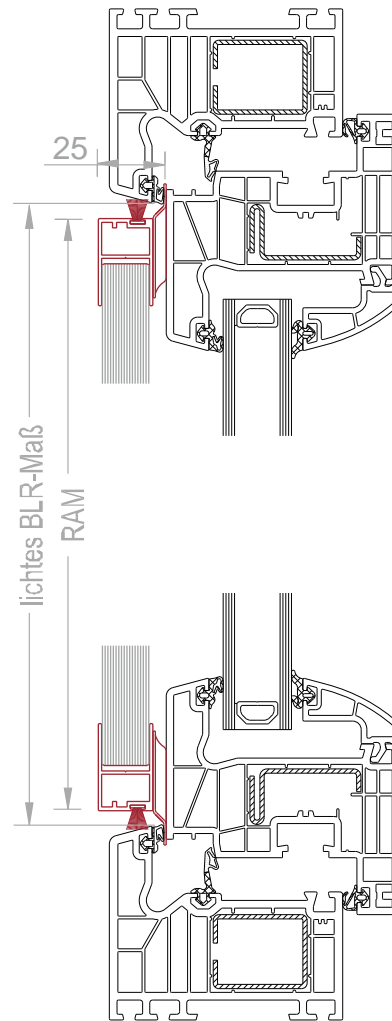
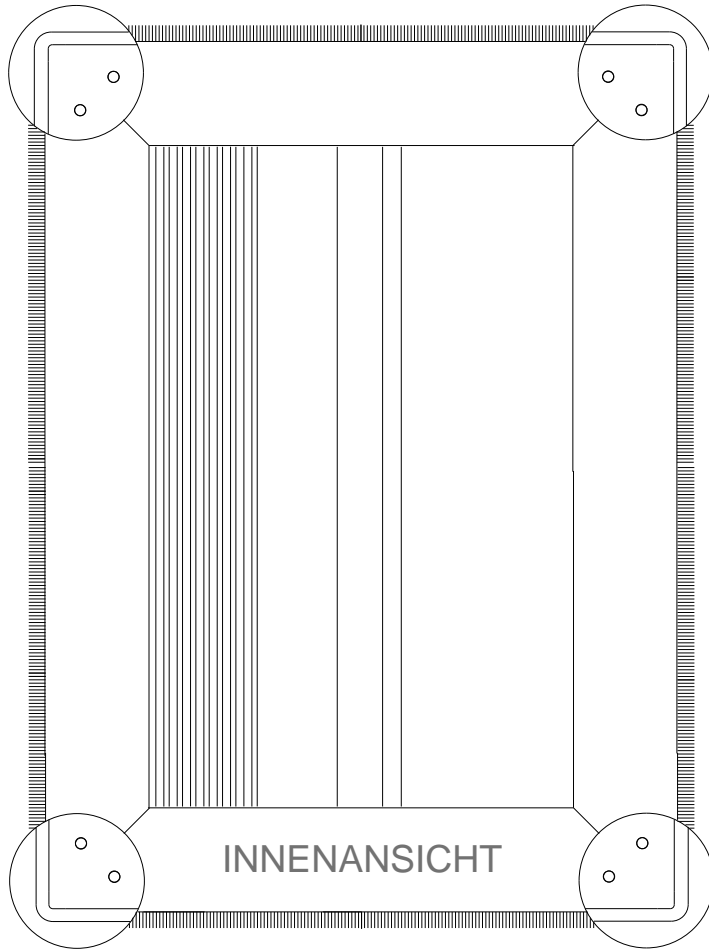

**Bitte beachten:**  
 Nur für flächenversetzte Fenster ohne  
 Wetterschenkel, Flügelabdeckprofil o.ä.  
 Empfehlung: Balkontür-Ziehgriff verwenden



### P20 - 230 R3 - EB

Plissee mit EASY<sup>2</sup> - Beschlag  
für Balkontüren mit umlaufendem Blendrahmen  
Rahmenprofil-R32 mit 10mm Bürste 3-seitig  
unten B8 Profil (EV1) mit Bodenkeil

Gesamtstärke 25mm

Bitte DIN-Richtung angeben

RAM Breite = licht. BLR - 5mm  
RAM Höhe = licht. BLR - 5mm

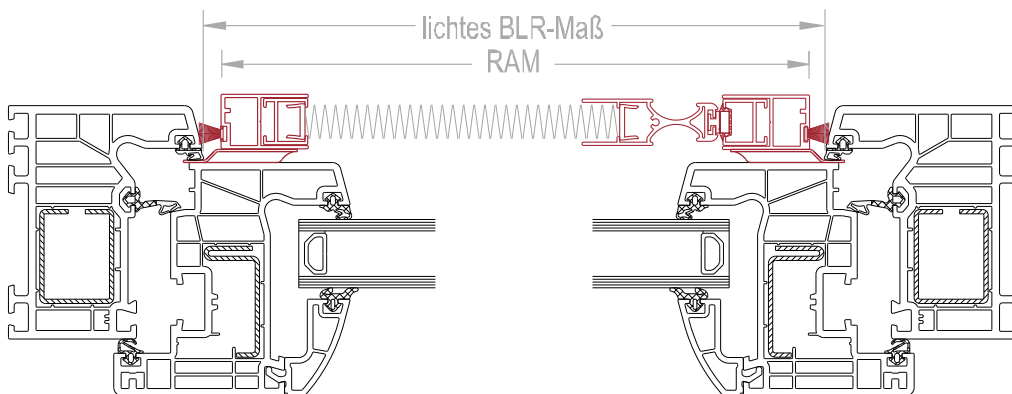
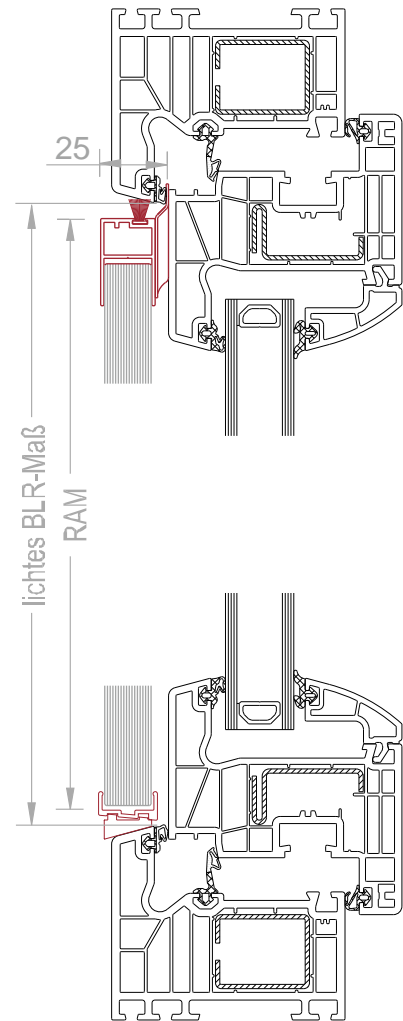
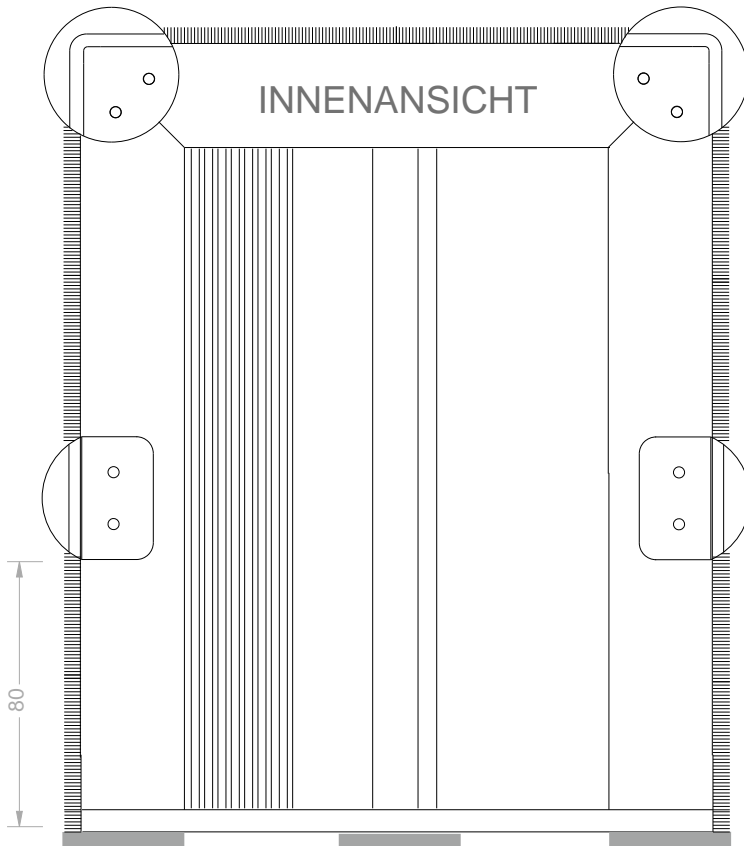

Bitte beachten:

Nur für flächenversetzte Fenster ohne  
Wetterschenkel, Flügelabdeckprofil o.ä.

Empfehlung: Balkontür-Ziehgriff verwenden



## P20 - 230 R3 - ES

Plissee mit EASY<sup>2</sup> - Beschlag  
für Balkontüren mit flacher Schwelle  
Rahmenprofil-R32 mit 10mm Bürste 3-seitig  
unten B8 Profil (EV1) mit 3mm Dichtband

Gesamtstärke 25mm

Bitte DIN-Richtung angeben

RAM Breite = licht. BLR - 5mm  
RAM Höhe = licht. BLR - 5mm

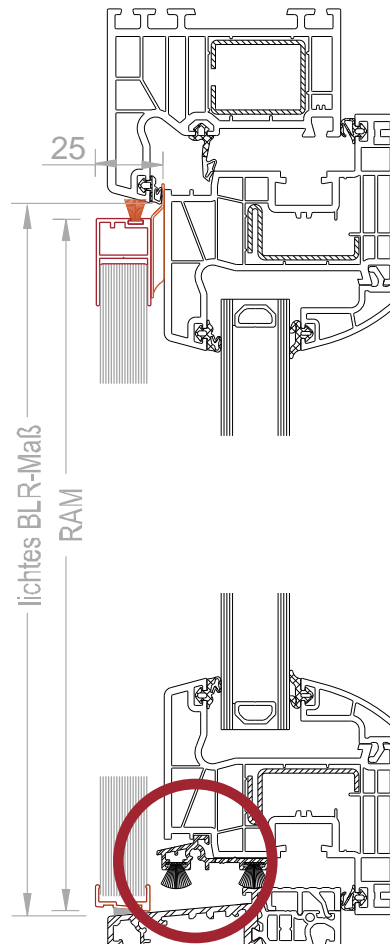
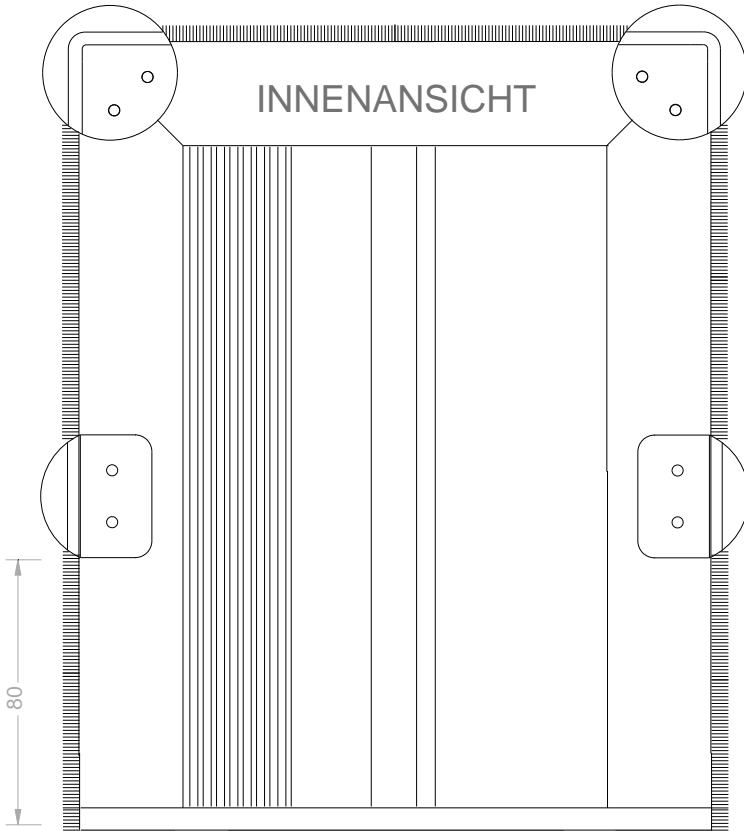

Wetterschenkel beachten!

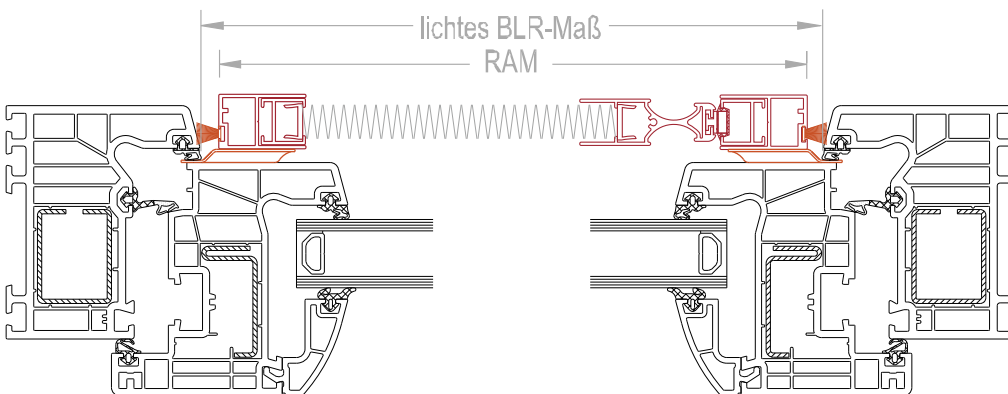

Bitte beachten:  
Nur für flächenversetzte Fenster ohne  
Wetterschenkel, Flügelabdeckprofil o.ä.  
Empfehlung: Balkontür-Ziehgriff verwenden



### Plissee 20 Fenster

Breite	400	600	800	1.000	1.200	1.400	1.600
Höhe							
400	308,-	330,-	352,-	372,-	394,-	415,-	436,-
600	324,-	346,-	368,-	388,-	409,-	431,-	451,-
800	340,-	362,-	383,-	404,-	425,-	447,-	467,-
1.000	356,-	378,-	399,-	420,-	441,-	463,-	483,-
1.200	372,-	394,-	415,-	436,-	457,-	479,-	499,-
1.400	388,-	409,-	431,-	451,-	473,-	495,-	515,-
1.600	404,-	425,-	447,-	467,-	489,-	511,-	531,-
1.800	420,-	441,-	463,-	483,-	505,-	527,-	547,-
2.000	436,-	457,-	479,-	499,-	521,-	543,-	563,-

### Plissee 20 Tür

Breite	400	600	800	1.000	1.200	1.400	1.600	1.800	2.000	2.200	2.400	2.600	2.800
Höhe													
400	308,-	324,-	340,-	356,-	372,-	388,-	404,-	420,-	436,-	451,-	467,-	483,-	499,-
600	330,-	346,-	362,-	378,-	394,-	409,-	425,-	441,-	457,-	473,-	489,-	505,-	521,-
800	352,-	368,-	383,-	399,-	415,-	431,-	447,-	463,-	479,-	495,-	511,-	527,-	543,-
1.000	372,-	388,-	404,-	420,-	436,-	451,-	467,-	483,-	499,-	515,-	531,-	547,-	563,-
1.200	394,-	409,-	425,-	441,-	457,-	473,-	489,-	505,-	521,-	537,-	553,-	569,-	585,-
1.400	415,-	431,-	447,-	463,-	479,-	495,-	511,-	527,-	543,-	559,-	574,-	590,-	606,-
1.600	436,-	451,-	467,-	483,-	499,-	515,-	531,-	547,-	563,-	579,-	595,-	611,-	627,-
1.800	457,-	473,-	489,-	505,-	521,-	537,-	553,-	569,-	585,-	600,-	616,-	632,-	648,-
2.000	488,-	504,-	519,-	535,-	551,-	567,-	583,-	599,-	615,-	631,-	647,-	663,-	679,-
2.200	530,-	545,-	561,-	577,-	593,-	609,-	625,-	641,-	657,-	673,-	689,-	705,-	721,-
2.400	583,-	599,-	615,-	631,-	647,-	663,-	679,-	695,-	710,-	726,-	742,-	758,-	774,-
2.600	666,-	681,-	697,-	713,-	729,-	745,-	761,-	777,-	793,-	809,-	825,-	841,-	857,-
2.800	768,-	784,-	800,-	816,-	832,-	848,-	864,-	880,-	896,-	912,-	927,-	943,-	959,-





380522-08-24

MELDEN SIE SICH IN UNSEREM SHOP AN



WIR SCHAFFEN VERBINDUNGEN  
[www.nuessing.de](http://www.nuessing.de)

**Nüßing**  
... mehr als Beschläge